

4CR

car refinish



DEU
ENG

Mit System schneller zum Ziel More efficiency in your production chain

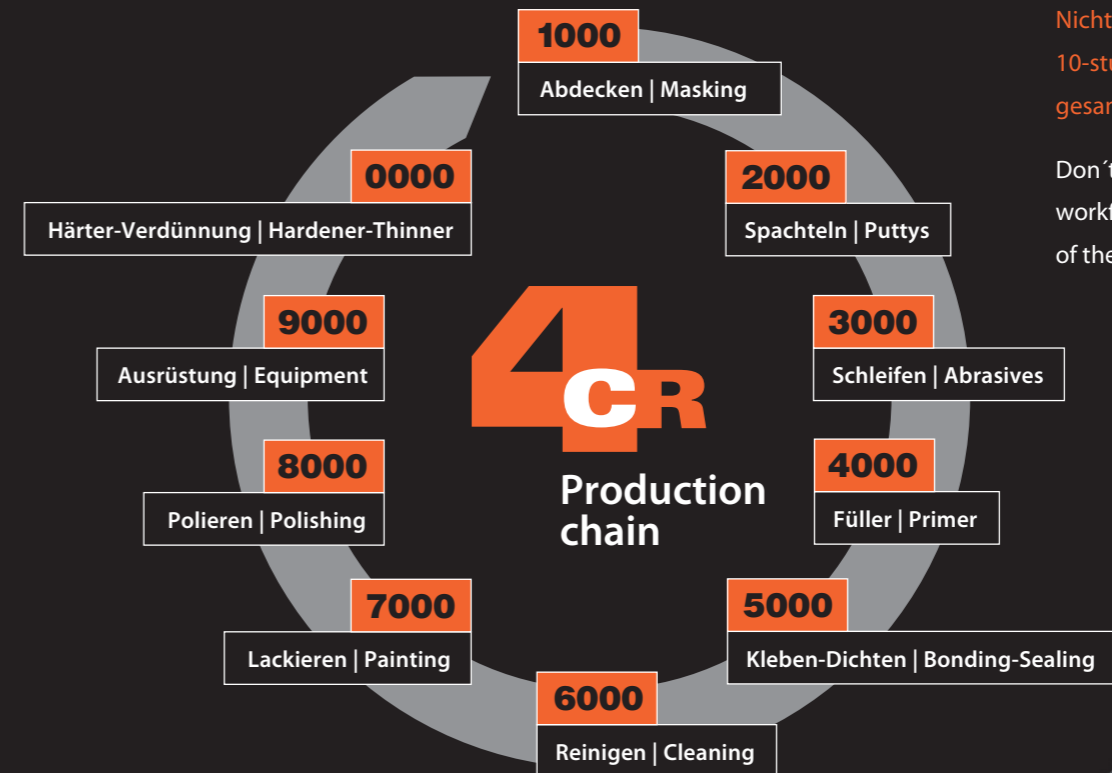

Nicht verpassen: Mit unserem 10-stufigen Workflow decken wir den gesamten Bedarf der Lackiervorstufe ab.

Don't miss out: with our 10-step workflow we cover the whole demand of the paint pre-stage.



Inhalt | Content

Abdecken Masking	05 - 10
Spachteln Puttys	11 - 16
Schleifen Abrasives	17 - 24
Füller Primer	25 - 28
Kleben-Dichten Bonding-Sealing	29 - 36
Reinigen Cleaning	37 - 46
Lackieren Painting	47 - 58
Polieren Polishing	59 - 66
Ausrüstung Equipment	67 - 74
Härter-Verdünnung Hardener-Thinner	75 - 79

Abdecken | Masking



Abdeckband 80°

1125



Masking Tape 80°

Beschreibung: Standard Abdeckband für Maler- und Lackierarbeiten. Temperaturbeständig bis 80°C.

Description: Semi-crepe paper-based masking tape for oven-baked painting operations up to 80°C/180°F in car body repair and other lacquering applications.

Art.-Nr. Part.-No.	Farbe Colour	Abmessung Size	VE/Stück Units
1125.1005	weiß - white	100mm x 50m	18
1125.1950	weiß - white	19mm x 50m	96
1125.2550	weiß - white	25mm x 50m	72
1125.3050	weiß - white	30mm x 50m	60
1125.3850	weiß - white	38mm x 50m	48
1125.5050	weiß - white	50mm x 50m	36

Abdeckband 80° Profi

1130

NEW



Masking Tape 80° Profi

Beschreibung: Profi Abdeckband für Maler- und Lackierarbeiten. Temperaturbeständig bis 80°C.

Description: Professional paper-based masking tape for oven-baked painting operations up to 80°C/180°F in car body repair and other lacquering applications.

Art.-Nr. Part.-No.	Farbe Colour	Abmessung Size	VE/Stück Units
1130.1950	gelb - yellow	19mm x 50m	48
1130.2550	gelb - yellow	25mm x 50m	36
1130.3050	gelb - yellow	30mm x 50m	32
1130.3850	gelb - yellow	38mm x 50m	24
1130.5050	gelb - yellow	50mm x 50m	24

Abdeckband Trillanium

1140



Trillanium Masking Tape

Beschreibung: Abdeckband der neuesten Generation. Sicherstes Abkleben bei allen Lackierarbeiten. Wasserfest und IR-beständig. Ebenfalls zum Abkleben von Scheibengummis und Kunststoffen geeignet. Temperaturbeständig bis 120°C.

Description: Premium professional masking tape. Waterproof and IR resistant. Excellent for masking rubber trim and plastic parts. Temperature resistant up to 120°C/250°F.

Art.-Nr. Part.-No.	Farbe Colour	Abmessung Size	VE/Stück Units
1140.1850	blau - blue	18mm x 50m	48
1140.2450	blau - blue	24 mm x 50m	36
1140.3050	blau - blue	30mm x 50m	28
1140.3650	blau - blue	36mm x 50m	24
1140.4850	blau - blue	48mm x 50m	24

Abdeckband orange

1141



Masking Tape orange

Beschreibung: Extra dünnes Abdeckband für Mehrfarben- und Designlackierungen sowie Abdeckarbeiten an Kunststoffteilen und Scheibengummis. Deutliche Reduzierung von Lackkanten. Hohe Kurvenstabilität und wasserfest. Temperaturbeständig bis 100°C.

Description: Finline and mask in one step. This very thin masking tape hardly leaves any paint edges. Top-quality, flexible and waterproof. Also suitable for masking rubber and plastic parts. Temperature resistant up to 210°F.

Art.-Nr. Part.-No.	Farbe Colour	Abmessung Size	VE/Stück Units
1141.1850	orange - orange	18mm x 50m	48

Radabdeckung

1144



Wheel Cover

Beschreibung: Sicheres und schnelles Abdecken von PKW-Rädern. Farbnebelhaftend.

Description: Quick and complete wheel covering. Slightly transparent. Easy to use.

Art.-Nr. Part.-No.	Farbe Colour	Abmessung Size	Ausführung Size	VE/Stück Units
1144.0500	weiß - white	74 x 81 x 16cm	500 Stück/RI. - pieces/roll	1 Rolle - roll

Einweg-Sitzschoner

1145



Disposable Seat Covers

Beschreibung: Einweg-Sitzschoner zum Schutz der Autositze vor Verunreinigungen während der Reparatur. Perfekter Sitz durch die rutschfeste Unterseite. Rollenbreite: 65 cm.

Description: Disposable non-slip seat covers to keep seats clean during repair. Perfect fit. Easy to use. Roll width: 65cm

Art.-Nr. Part.-No.	Farbe Colour	Abmessung Size	Ausführung Size	VE/Stück Units
1145.0500	weiß - white	82 x 127cm	500 Stück/RI. - pieces/roll	1 Rolle - roll

Art.-Nr. Part.-No.

Farbe Colour

Ausführung Size

VE/Stück Units

1146.0001	-	Dispenser - dispenser	1
1146.0150	transparent - transparent	12,5cm x 150 m	40

Steering Wheel Cover

Beschreibung: Stretchfolie zum Schutz des Lenkrades während der Reparatur. Einfache Handhabung mithilfe des Dispensers. Schmiegt sich jedem Lenkrad gleich gut an, egal ob aus Leder, Holz oder Kunststoff. Schützt auch Schalthebel und Handbremsen.

Description: Disposable stretch film for steering wheel protection. Easy to use. Dispenser available. Suitable for all steering wheels such as leather, wood or plastics. Protects gearshifts and handbrakes as well.

Lenkradschutz

1146



Art.-Nr. Part.-No.

Abmessung Size

Ausführung Size

VE/Stück Units

1147.0500	38 x 50cm	500 Stck./Kar. - pieces/box	1 Karton - case
-----------	-----------	-----------------------------	-----------------

Floor mat Paperplast

Beschreibung: Fußmatte zur Reinhaltung des Fahrzeuges während der Reparatur. Kombiniert die Vorteile von Papier und Folie: - Das Papier oben saugt Wasser und Öl auf. - Die Folie unten verhindert ein Durchnässen.

Description: Floor mat to keep vehicles clean during repair. Combines the advantages of paper and plastic: The paper on top absorbs water and oil, the plastic underneath prevents that water seeps through.

Fußmatte Paperplast

1147



Art.-Nr. Part.-No.

Abmessung Size

VE/Stück Units

1149.4200	4m x 200m	1
1149.4400	4m x 400m	1

Masking Plastic 9 µ

Beschreibung: Abdeckfolie zum schnellen Abdecken von Fahrzeugen und Fahrzeugteilen vor der Lackierung. Statisch, IR-beständig, leicht transparent. Temperaturbeständig bis 110°C. Lackhaftend.

Description: Abdeckfolie zum schnellen Abdecken von Fahrzeugen und Fahrzeugteilen vor der Lackierung. Statisch, IR-beständig, leicht transparent. Temperaturbeständig bis 110°C. Lackhaftend.

Abdeckfolie 9 µ

1149



Art.-Nr. Part.-No.

Abmessung Size

Ausführung Size

VE/Stück Units

1150.1600	1m x 600m	1
1150.2300	2m x 300m	1
1150.4200	4m x 200m	1
1150.4300	4m x 300m	1
1150.6540	6,5m x 4m	1 x 25

Masking Plastic Profi

Beschreibung: Abdeckfolie zum schnellen Abdecken von Fahrzeugen und Fahrzeugteilen vor der Lackierung. Statisch, lackhaftend, IR-beständig, leicht transparent, extrem strapazierfähig. Temperaturbeständig bis 110°C.

Description: Professional masking film. Fastest and easiest way of masking cars or car parts before painting. Static, holds overspray, IR resistant, slightly transparent.

Abdeckfolie Profi

1150



Art.-Nr. Part.-No.

Abmessung Size

Ausführung Size

VE/Stück Units

1151.3820	3,8m x 200m	1
1151.4200	4 m x 200m	1
1151.4300	4 m x 300m	1
1151.4400	4m x 400m	1
1151.5150	5m x 150m	1

Masking Plastic light

Beschreibung: Light Abdeckfolie zum schnellen Abdecken von Fahrzeugen und Fahrzeugteilen vor der Lackierung. Statisch, IR-beständig, leicht transparent, extrem strapazierfähig. Temperaturbeständig bis 110°C. Lackhaftend, außer 1151.3820.

Description: Lightweight masking film. Fastest and easiest way of masking cars and car parts. Static, IR resistant, slightly transparent. Holds all overspray (except for 1151.3820).

Abdeckfolie Light

1151



Art.-Nr. Part.-No.

Abmessung Size

VE/Stück Units

1152.0001	Dispenser - dispenser 55cm	1
1152.0002	Dispenser - dispenser 110 + 140cm	1
1152.0055	55cm x 33m	60
1152.0110	110cm x 33m	30
1152.0140	140cm x 33m	30

Plastic Roll

Beschreibung: Abdeckfolie mit integriertem Klebeband zum schnellen Abdecken von Fahrzeugteilen. Statisch aufgeladen, dadurch selbsthaftend.

Description: Masking Plastic with integrated masking tape for quick and handy masking of car parts. Perfect for fast masking of large areas. 1152 is electrostatically charged, and therefore self-adhesive.

Folienrolle

1152



Abdeckplane

1155



Masking Plastic

Art.-Nr. Part.-No. 1155.4050

Abmessung Size 4 x 5m

VE/Stück Units 20

Beschreibung: Einzelpackte Folienstücke. Für das Abdecken und den Schutz von Gegenständen und Materialien in den verschiedensten Bereichen.

Description: Single packed 4m x 5m foil pieces for the masking and protection of various objects. Thickness 7 my.

Entsorgungsbeutel

1159



Waste Bag

Art.-Nr. Part.-No. 1159.0001

Ausführung Size 1,8 x 1m

VE/Stück Units 70

Beschreibung: Zur Entsorgung von Folien.

Description: For disposal of masking plastic.

Abdeckkraftpapier

1160

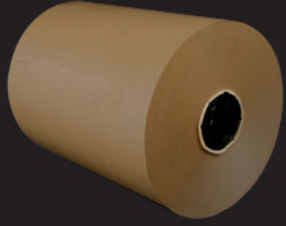

Kraft Masking Paper

Art.-Nr. Part.-No. 1160.0020, 1160.0045, 1160.0060, 1160.0090, 1160.0120, 1160.0150

Abmessung Size 20cm x 450m, 45cm x 450m, 60cm x 450m, 90cm x 450m, 120cm x 450m, 150cm x 450m

VE/Stück Units 1, 1, 1, 1, 1, 1

Beschreibung: Durchschlagbeständiges und lösemittelresistentes Kraftpapier zum Abdecken von Fahrzeugen und Fahrzeugteilen vor der Lackierung. Hitzebeständig bis 200°C. Stärke: 40 g/m²

Description: Finely milled, high strength kraft paper. For covering vehicle body panels when painting. Its density makes it impervious to coatings. Thin and flexible for ease use. Weight: 40 g/m².

Abdeckpapier 50 g

1165



Masking Paper 50 g

Art.-Nr. Part.-No. 1165.0022, 1165.0060, 1165.0090, 1165.0120, 1165.01550

Abmessung Size 22cm x 300m, 60cm x 300m, 90cm x 300m, 120cm x 300m, 150cm x 300m

VE/Stück Units 1, 1, 1, 1, 1

Beschreibung: Durchschlagbeständiges und lösemittelresistentes Papier zum Abdecken von Fahrzeugen und Fahrzeugteilen vor der Lackierung. Stärke: 50 g/m²

Description: For covering vehicle body panels when painting. Its density makes it impervious to coatings. Thin and flexible for ease use. Solvent resistant. Weight: 50 g/m².

Fine Line Tape grün

1170



Fine Line Tape green

Art.-Nr. Part.-No. 1170.0355, 1170.0655, 1170.0955, 1170.1255

Farbe Colour grün - green, grün - green, grün - green, grün - green

Abmessung Size 3mm x 55m, 6mm x 55m, 9mm x 55m, 12mm x 55m

VE/Stück Units 10, 10, 10, 10

Beschreibung: Abdeckband für Mehrfarben- und Designlackierungen. Höchst flexibel und daher besonders für Kurven geeignet. Temperaturbeständig bis 132°C.

Description: Highly flexible tape for multi color and design paint jobs. Easy to curve. Temperature resistant up to 132°C/270°F.

Fine Line Tape orange

1171



Fine Line Tape orange

Art.-Nr. Part.-No. 1171.0355, 1171.0655, 1171.0955, 1171.1255

Farbe Colour orange - orange, orange - orange, orange - orange, orange - orange

Abmessung Size 3mm x 55m, 6mm x 55m, 9mm x 55m, 12mm x 55m

VE/Stück Units 10, 10, 10, 10

Beschreibung: Abdeckband für Mehrfarben- und Designlackierungen. Speziell für lange und gerade Linien entwickelt und trotzdem flexibel. Temperaturbeständig bis 138°C.

Description: Masking tape for multi colour and design paint jobs. Designed for long and straight lines whilst remaining flexible. Temperature resistant up to 150°C/302°F.

Fine Line Tape blue

1172



Art.-Nr. Part.-No. 1172.0333, 1172.0633, 1172.0933, 1172.1233

Farbe Colour blau - blue, blau - blue, blau - blue, blau - blue

Abmessung Size 3mm x 33m, 6mm x 33m, 9mm x 33m, 12mm x 33m

VE/Stück Units 10, 10, 10, 10

Beschreibung: Abdeckband für Mehrfarben- und Designlackierungen. Sowohl für Kurven als auch für lange, gerade Linien geeignet. Hohe Formanpassungsfähigkeit. Temperaturbeständig bis 138°C.

Description: Medium flexible tape for multi colour and design jobs. It follows contours and remains in place as long as necessary. Temperature resistant up to 138°C/280°F.

Fine Line Tape olive

1173



Art.-Nr. Part.-No. 1173.0355, 1173.0655, 1173.0955, 1173.1255

Farbe Colour oliv - olive, oliv - olive, oliv - olive, oliv - olive

Abmessung Size 3mm x 55m, 6mm x 55m, 9mm x 55m, 12mm x 55m

VE/Stück Units 10, 10, 10, 10

Beschreibung: Abdeckband für Mehrfarben- und Designlackierungen. Starres Tape, speziell für lange und gerade Linien entwickelt. Temperaturbeständig bis 138°C.

Description: Rigid tape for multi colour and design paint jobs. Designed for long and straight line jobs. Temperature resistant up to 138°C/280°F.

Striping Tape

1180



Art.-Nr. Part.-No. 1180.2514

Farbe Colour oliv - olive

Abmessung Size 25mm x 14m

VE/Stück Units 10

Beschreibung: Vorgestanztes flexibles Farblinienband für Dekorstreifen. Acht Streifen à 1,5 mm Breite ermöglichen verschiedene Breiten oder mehrere Streifen. Temperaturbeständig bis 138°C.

Description: Pre-cut flexible fine line tape designed for making striping cars a simple job allowing a multitude of patterns. 8 stripes x 1,5mm.

Aluminium Tape

1185

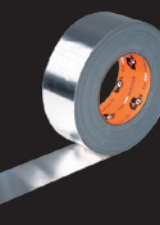

Art.-Nr. Part.-No. 1185.5050

Abmessung Size 50mm x 50m

VE/Stück Units 24

Beschreibung: Zum Schutz vieler empfindlicher Oberflächen. Spezieller Schutz von Kunststoffen gegen Hitze und Infrarotstrahlen. Gute Leitfähigkeit.

Description: Aluminium masking tape to protect sensitive surfaces against heat and infrared. Thanks to its conductive properties, this tape is applied in freezers and refrigerators manufacturing where it is necessary to obtain a good thermal conductivity.

Cloth Tape

1190

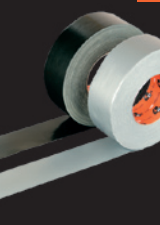

Art.-Nr. Part.-No. 1190.5050, 1190.5051, 1190.5052

Farbe Colour silber - silver, silber - silver, schwarz - black

Abmessung Size 48mm x 54,8m, 50mm x 50m, 50mm x 50m

Ausführung Size Kantenschutz - edge protection, Sandstrahlen - sandblasting, Sandstrahlen - sandblasting

VE/Stück Units 24, 18, 18

Beschreibung: Speziell beschichtetes Gewebeband für hohe Beanspruchungen und nahezu alle Einsatzbereiche. Gute Wasserbeständigkeit und sehr hohe Klebkraft auf einer Vielzahl von Oberflächen.

Description: High quality specially coated, water and sanding resistant adhesive tape with outstanding adhesive power for almost every field of application. Can easily be removed after use.

Lifting Tape

1195







Art.-Nr. Part.-No. 1195.5010

Abmessung Size 50mm x 10m

VE/Stück Units 10

Beschreibung: Abdeckhilfe bei schwierigen Abdekarbeiten an Autos; besonders an Dichtungen, Fenstern, Türen, Schiebedächern, Motorhauben, Kofferraumdeckeln, Front- und Rückscheiben. Temperaturbeständig bis 150°C.

Description: Perforated masking tape designed for masking window trims. Waterproof, silicone-free, temperature resistant up to 150°C/300°F.

Folienschneider 1199 	Cutter for masking plastic Beschreibung: Zum Schneiden von Abdeckfolien. Description: Cutter for masking plastic.	Art.-Nr. Part.-No. 1199.0001	VE/Stück Units 100
Foam Masking Tape 1200 	Foam Masking Tape Beschreibung: Universelles Schaumklebeband zum Abdecken von Spalten an beweglichen Fahrzeugteilen wie Türen, Motorhauben oder Kofferraumdeckeln. Endlosrolle für Spaltenbreiten von 2-20 mm. Temperaturbeständig bis 95°C. Description: Adjustable foam masking tape for masking all gaps on vehicles. Continuous roll. Temperature resistant up to 95°C/194°F.	Art.-Nr. Part.-No. 1200.5000	Abmessung Size 20mm x 50m VE/Stück Units 1
Soft Masking Foam Tape 1205 	Soft Masking Foam Tape Beschreibung: Standard Schaumklebeband zum Abdecken von Spalten an beweglichen Fahrzeugteilen wie Türen, Motorhauben, oder Kofferraumdeckeln. Zur Vermeidung harter Lackkanten. Einsatz nach herkömmlicher Methode. Temperaturbeständig bis 90°C. Description: Standard foam masking tape for masking vehicle gaps the traditional way minimising any hard paint edges. Continuous Temperature resistant up to 90°C/194°F.	Art.-Nr. Part.-No. 1205.1350 1205.1950	Abmessung Size 13mm x 50m 19mm x 50m VE/Stück Units 1 1
Füllerband 1208 	Primermask Beschreibung: Neues Abdeckband zum Abdichten von Türspalten und Blendenöffnungen als Schutz vor Füller/Primer - Overspray. Deutliche Zeiterparnis gegenüber herkömmliche Abdeckarbeiten. Sehr einfache Anwendung. Description: New masking product for sealing door gaps and vehicle apertures. The product can dramatically speed up the time it takes to seal and protect vehicle panel gaps prior to the priming application. No primer build up on panel edges. Easy to apply.	Art.-Nr. Part.-No. 1208.1535	Abmessung Size 15mm x 35m VE/Stück Units 1
Schaumklebeband 1210 	No Edge Blending Tape Beschreibung: 1210 ist eine Kombination aus Abdeckband und Schaumband zum Abdecken von Sicken und Kanten, um harte Lackkanten zu vermeiden. Temperaturbeständig bis 110°C. Description: No edge blending tape for allowing seamless blending of new paint work into old. Non-stretch. One size works for all applications. Temperature resistant up to 110°C/230°F.	Art.-Nr. Part.-No. 1210.2005	Abmessung Size 20mm x 5m VE/Stück Units 10
Packband 4CR 1250 	4CR Packing Tape Beschreibung: Universelles Kartonverschlussband mit 4CR-Logo. Ideal für schwere Verpackungen. Chemikalienresistent. Hohe Klebkraft. Description: For sealing boxes and many other packaging applications subjected to rough shipping conditions or that require a higher sealing performance. With 4CR logo.	Art.-Nr. Part.-No. 1250.5066	Abmessung Size 50mm x 66m VE/Stück Units 36

Spachteln | Puttys



Füllspachtel

2010



Base Putty

Beschreibung: Zum Füllen tiefer Unebenheiten, auch an senkrechten Flächen. Hohe Füllkraft, leicht schleifbar.

Description: For filling deep dents, even on vertical surfaces. High filling capability, easy sanding.

Art.-Nr. Part.-No.	Ausführung Size	VE/Stück Units
2010.0251	250 g mit Haube - incl. hood	10
2010.0501	500 g mit Haube - incl. hood	12
2010.1000	1 kg inkl. Härter - incl. hardener	6
2010.1001	1 kg mit Haube - incl. hood	12
2010.2000	2 kg inkl. Härter - incl. hardener	6

Fiberglass Putty

2100



Beschreibung: Zum Füllen sehr großer Unebenheiten, zur Reparatur kleiner Roststellen. Direkte Haftung auf Blech, Aluminium und verzinkten Untergründen. Sehr gut schleifbar.

Description: Fill imperfections on a variety of large surfaces, including steel, aluminum, galvanized and fiberglass surfaces. Will even adhere to small rust areas. Easy sanding.

Art.-Nr. Part.-No.	Ausführung Size	VE/Stück Units
2100.0251	250 g mit Haube - incl. hood	10
2100.0501	500 g mit Haube - incl. hood	12
2100.1000	1 kg inkl. Härter - incl. hardener	6
2100.1001	1 kg mit Haube - incl. hood	12
2100.1800	1,8 kg inkl. Härter - incl. hardener	6

Glasspachtel

2100



Softspachtel

2015



Soft Putty

Beschreibung: Zum Füllen tiefer Unebenheiten. Hohe Füllkraft, superleicht schleifbar.

Description: For filling small dents and holes. High filling performance, very easy sanding.

Art.-Nr. Part.-No.	Ausführung Size	VE/Stück Units
2015.0900	0,9 kg inkl. Härter - incl. hardener	6
2015.1800	1,8 kg inkl. Härter - incl. hardener	6
2015.2700	2,7 kg Kartusche - cartridge	4
2015.9000	9,0 kg Kartusche - cartridge	2

Elastic Putty white

2200



Beschreibung: Zum Füllen von kleinen und großen Unebenheiten. Porenfreie Oberfläche. Sehr leicht schleifbar.

Description: One-coat putty that leaves a pin-hole free, easy to sand top surface. Adheres to body filler, metal, fiberglass and plastic. Elastic, non-shrink formulation.

Art.-Nr. Part.-No.	Ausführung Size	VE/Stück Units
2200.0010	10 kg Kartusche - cartridge	2
2200.0251	250 g mit Haube - incl. hood	10
2200.0501	500 g mit Haube - incl. hood	12
2200.1000	1 kg inkl. Härter - incl. hardener	6
2200.1001	1 kg mit Haube - incl. hood	12
2200.2000	2 kg inkl. Härter - incl. hardener	6

Elasticspachtel weiß

2200



Aluspachtel

2020



Metallic Putty

Beschreibung: Zum Füllen tiefer Unebenheiten. Durch Aluminiumanteile sehr hohe Dichte. Leicht schleifbar. Haftet auch auf Aluminium und verzinkten Oberflächen.

Description: For filling deep dents. High density due to aluminum content. Easy sanding.

Art.-Nr. Part.-No.	Ausführung Size	VE/Stück Units
2020.1000	1 kg inkl. Härter - incl. hardener	6
2020.2000	2 kg inkl. Härter - incl. hardener	6

Elastic Putty beige

2210



Beschreibung: Zum Füllen von kleinen und großen Unebenheiten. Porenfreie Oberfläche. Sehr leicht schleifbar.

Description: One-coat putty that leaves a pin-hole free, easy to sand top surface. Adheres to body filler, metal, fiberglass and plastic. Elastic, non-shrink formulation.

Art.-Nr. Part.-No.	Ausführung Size	VE/Stück Units
2210.1000	1 kg inkl. Härter - incl. hardener	6
2210.2000	2 kg inkl. Härter - incl. hardener	6
2210.3000		

Elasticspachtel beige

2210



Hartspachtel

2025



Hard Putty

Beschreibung: Zum Reparieren von Tankstutzen, Außenspiegeln, Kanten und Bördeln. Sehr hoher Härtegrad.

Description: Repairing of gasoline necks, exterior mirrors, edges and mudguards. Very high degree of hardness.

Art.-Nr. Part.-No.	Ausführung Size	VE/Stück Units
2025.1000	1 kg inkl. Härter - incl. hardener	6

Multifunctional Putty

2300



Beschreibung: Ein Produkt für alle Anwendungen. Füll- und Feinspachtel. Haftet auf allen Untergründen im PKW-Reparaturbereich, inklusive allen Verzinkungen. Leicht schleifbar.

Description: One product for all uses. Base and fine putty. Adheres to all vehicle surfaces, including galvanized surfaces. Easy sanding.

Art.-Nr. Part.-No.	Ausführung Size	VE/Stück Units
2300.0010	10 kg Kartusche - cartridge	2
2300.0251	250 g mit Haube - incl. hood	10
2300.0501	500 g mit Haube - incl. hood	12
2300.1000	1 kg inkl. Härter - incl. hardener	6
2300.1500	1,5 kg Kartusche - cartridge	6
2300.2000	2 kg inkl. Härter - incl. hardener	6
2300.3000	3 kg Kartusche - cartridge	4

Multispachtel

2300



Kunststoffkonturenspachtel

2030



Contour Putty for Plastics

Beschreibung: Zur Reparatur kleiner Kratzer und Lunker an Kunststoffteilen. Leicht schleifbar.

Description: Repair small scratches and imperfections on plastic parts. Easy sanding.

Art.-Nr. Part.-No.	Ausführung Size	VE/Stück Units
2030.1000	1 kg inkl. Härter - incl. hardener	6

Multi Soft Putty

2350



Beschreibung: Ein Produkt für alle Anwendungen. Füll- und Feinspachtel. Haftet auf allen Untergründen im PKW-Reparaturbereich, inklusive allen Verzinkungen. Sehr leicht schleifbar.

Description: A high-build and skimming putty in one product that adheres well to all surfaces. Very easy to sand with finer grit paper, which eliminates the risk of sand scratch swelling.

Art.-Nr. Part.-No.	Farbe Colour	Ausführung Size	VE/Stück Units
2350.0800	hellgrau - light-grey	0,8 kg inkl. Härter - incl. hardener	6
2350.1400	hellgrau - light-grey	1,4 kg Kartusche - cartridge	6
2350.1600	hellgrau - light-grey	1,6 kg inkl. Härter - incl. hardener	6
2350.2632	hellgrau - light-grey	2,6 kg Kartusche - cartridge	4
2350.9000	hellgrau - light-grey	9 kg Kartusche - cartridge	2

Multi Soft Spachtel

2350



Zinnersatzspachtel

2040



All Metal Putty

Beschreibung: Mit Aluminium-Pigmentierung zum Ausfüllen grober Unebenheiten, Poren und Bohrungen im Fahrzeugbau. Gut schleifbar; hohe Elastizität; kann als Schwemmsatz verwendet werden.

Description: With lamellar aluminium pigmentation. Used to fill coarse irregularities, pores and pin holes in the car body. Good sandability; high elasticity; to be also used as replacement of fluid tin in filling operations.

Art.-Nr. Part.-No.	Ausführung Size	VE/Stück Units
2040.2000	2 kg inkl. Härter - incl. hardener	6

Trillanium Multi Soft Putty

2355



Beschreibung: Ein Produkt für alle Anwendungen. Füll- und Feinspachtel. Haftet auf allen Untergründen im PKW-Reparaturbereich, inklusive allen Verzinkungen. Sehr leicht schleifbar.

Description: A high-build and skimming putty in one product that adheres well to all surfaces. Very easy to sand with finer grit paper, which eliminates the risk of sand scratch swelling.

Art.-Nr. Part.-No.	Farbe Colour	Ausführung Size	VE/Stück Units
2355.1600	blau - blue	1,6 kg inkl. Härter - incl. hardener	6

Multi Soft Spachtel Trillanium

2355



Streichspachtel

2400



Brushable Putty

Art.-Nr. Part.-No. 2400.1000

Ausführung Size 1 kg inkl. Härter - incl. hardener

VE/Stück Units 6

Beschreibung: Zum Füllen von Schleifspuren. Spachteln von Rundungen, Kanten und Ecken. Sehr leicht schleifbar. Pinselverarbeitung.

Description: For filling of sanding scratches. Application on curved surfaces and corners. Very easy sanding. Apply with a brush.

Spritzfüller

2500



Spray Filler

Art.-Nr. Part.-No. 2500.1500

Ausführung Size 1,5 kg inkl. Härter - incl. hardener

VE/Stück Units 6

Beschreibung: 2K-Polyester-Spritzfüller zum Füllen von Poren und Schleifriefen. Schnelle Durchtrocknung. Sehr leicht schleifbar.

Description: 2K polyester spray filler. Excellent adhesion to all surfaces. Fills holes and scratches. Levels uneven surfaces. Dries quickly. Easy sanding.

Nitrokombispachtel

2620



Nitrocellulose Putty

Art.-Nr. Part.-No. 2620.0900

Ausführung Size 900 g

VE/Stück Units 6

Beschreibung: 1K-Spachtel zum Ausgleich von Kratzern und Steinschlagschäden. Nitrobasis.

Description: 1K Putty for filling scratches and stone-chips while in the paint booth. Nitrocellulose base.

Porenwischfüller

2650



Pore Sealer

Art.-Nr. Part.-No. 2650.0250

Ausführung Size 250 g

VE/Stück Units 6

Beschreibung: 1K-Wischfüller zum Ausfüllen von Mikroporen, insbesondere im Kunststoffbereich.

Description: 1K Putty used to fill micro-pores, especially in plastic parts.

Spachtelmischbrett

2690



Putty Board

Art.-Nr. Part.-No. 2690.0100

Ausführung Size 100 Blatt - Sheets

VE/Stück Units 1

Beschreibung: Spachtelmischbrett zum Anmischen von Polyester-Spachtelmassen. Immer eine saubere Fläche!

Description: For mixing 2-component polyester putties. 100 sheets silicone-free, special water-proofed paper.

Spachtelklingen

2710



Putty Knife

Art.-Nr. Part.-No. 2710.0060, 2710.0080, 2710.0100

Ausführung Size 60mm, 80mm, 100mm

VE/Stück Units 12, 12, 12

Beschreibung: Stahlspachtel mit lösungsmittelbeständigem Kunststoffgriff.

Description: Steel spreader with solvent resistant plastic handle.

Art.-Nr. Part.-No. 2711.0120

Ausführung Size 120mm

VE/Stück Units 10

Plastic Spreader

Beschreibung: Kunststoffspachtel, bruchsicher und lösungsmittelbeständig.

Description: Plastic spreader, non-breakable and solvent resistant.



Art.-Nr. Part.-No. 2712.1006, 2712.8050

Abmessung Size 100 x 60mm, 80 x 50mm

VE/Stück Units 10, 10

Rubber Spreader

Beschreibung: Gummispachtel zum Spachteln von Rundungen. Lösungsmittelbeständig.

Description: Rubber based spreader for applying putty in curves. Solvent resistant.

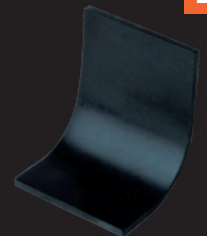

Art.-Nr. Part.-No. 2713.0001

Ausführung Size Set à 4 Stck. - pcs.

VE/Stück Units 1

Japan Spreader Set

Beschreibung: Stahlspachtel, bruchsicher. 5, 8, 10 und 12 cm breit.

Description: Steel spreader, non-breakable. Widths of 2", 3", 4" and 5".

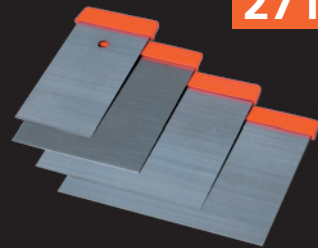

Art.-Nr. Part.-No. 2810.0250, 2810.1000, 2810.5000

Ausführung Size 250 g inkl. Härter - incl. hardener, 1 kg inkl. Härter - incl. hardener, 5 kg ohne Härter - w/o hardener

VE/Stück Units 12, 6, 4

Polyester Resin

Beschreibung: Polyesterharz zur Verarbeitung von Glastatten und Glasgeweben.

Description: Polyester resin for repairing with fiberglass.



Art.-Nr. Part.-No. 2820.0250, 2820.1000

Ausführung Size 250 g Set - set, 1 kg Set - set

VE/Stück Units 12, 6

Polyester Repair Set

Beschreibung: Zur Reparatur von GFK-Teilen und kleinen Rostlöchern. Set, bestehend aus Polyesterharz, Härter und Glasgewebe.

Description: For repairing GRP parts and small rust holes. Set contains polyester resin, hardener and fiberglass.



Art.-Nr. Part.-No. 2831.1000

Abmessung Size 1 m²

VE/Stück Units 10

Fiberglass Cloth

Beschreibung: Glasgewebe zur Verarbeitung mit Polyesterharz. 165 g/m².

Description: Fiberglass cloth for working with polyester resin. 165 g/m².



Plastikspachtel

2711



Gummispachtel

2712



Japanspachtel-Set

2713

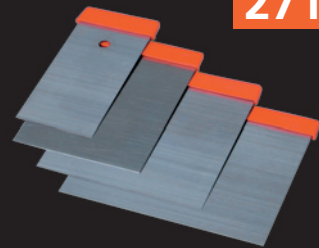

Reparaturharz

2810



Reparaturset

2820



Glasgewebe

2831



2832 	Fiberglass Mat Beschreibung: Glastmatte zur Verarbeitung mit Polyesterharz. 300 g/m ² . Description: Fiberglass mat for working with polyester resin. 300 g/m ² .	Art.-Nr. Part.-No. 2832.1000	Abmessung Size 1 m ²	VE/Stück Units 10	
2900 	BPO Hardener tube Beschreibung: Benzoylperoxid-Härter zur Aushärtung von Polyestersystemen. Description: Benzoyl peroxide hardener for activating polyester putties.	Art.-Nr. Part.-No. 2900.0025 2900.0050 2900.0051 2900.0052	Farbe Colour rot - red rot - red weiß - white blau - blue	Ausführung Size 25 g 50 g 50 g 50 g	VE/Stück Units 1 1 1 1
2910 	BPO Hardener cartridge Beschreibung: Benzoylperoxid-Härter zur Aushärtung von Polyestersystemen. Description: Benzoyl peroxide hardener for activating polyester putties.	Art.-Nr. Part.-No. 2910.0040 2910.0060 2910.0160	Farbe Colour rot - red rot - red rot - red	Ausführung Size 40 g 60 g 160 g	VE/Stück Units 1 1 1
2920 	CHP Hardener Beschreibung: Flüssiger Härter für 4CR 2500 Spritzfüller. Description: Liquid hardener for 4CR 2500 Spray Filler.	Art.-Nr. Part.-No. 2920.0050	Ausführung Size 50 ml	VE/Stück Units 1	

2355 Multi Soft Spachtel Trillanium Trillanium Multifunct. Soft Putty



Ein Produkt für alle Anwendungen. Füll- und Feinspachtel. Haftet auf allen Untergründen im PKW-Reparaturbereich, inklusive allen Verzinkungen. Sehr leicht schleifbar.

A high-build and skimming putty in one product that adheres well to all surfaces. Very easy to sand with finer grit paper, which eliminates the risk of sand scratch swelling.

Schleifen | Abrasives

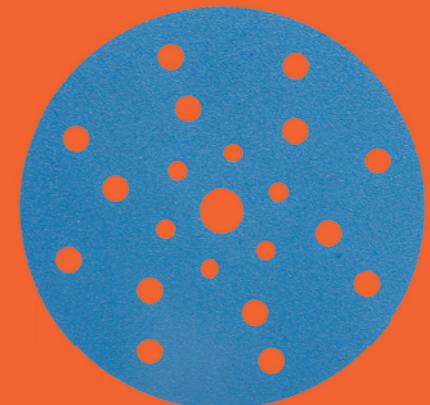

Gold 150 mm, Velcro, 15-Loch

3050 NEW



Gold, 6 inch, Velcro, 15-hole

Beschreibung: Universell einsetzbares Schleifmittel, welches sich vor allem durch ausgezeichnete Standzeit, beständige Schleifleistung und exzellentes Finish auszeichnet. Kletthaftend.

Description: Multipurpose abrasive, designed for use in body and paint shops. 3050 has a good and equal removal performance as well as a high durability and stability. Long life. Velcro backing.

Art.-Nr. Part.-No.	Körnung Grit	VE/Stück Units
3050.0040	P 40	50
3050.0060	P 60	50
3050.0080	P 80	50
3050.0120	P 120	100
3050.0150	P 150	100
3050.0180	P 180	100
3050.0220	P 220	100
3050.0240	P 240	100
3050.0280	P 280	100
3050.0320	P 320	100
3050.0360	P 360	100
3050.0400	P 400	100
3050.0500	P 500	100
3050.0600	P 600	100
3050.0800	P 800	100

150 mm, Velcro, 7-Loch

3100



6 inch, Velcro, 7-hole

Beschreibung: Spezialschleifmittel für die professionelle Anwendung in Autolackierereien. Für Grob-, Zwischen- und Endschliff. Sehr gute Standzeit und exzellentes Finish. Kletthaftend.

Description: Special abrasive, designed for use in body and paint shops. For coarse, interim and final sanding. Long life and excellent finish. Velcro backing.

Art.-Nr. Part.-No.	Körnung Grit	VE/Stück Units	Art.-Nr. Part.-No.	Körnung Grit	VE/Stück Units
3100.0040	P 40	50	3100.0320	P 320	100
3100.0060	P 60	50	3100.0360	P 360	100
3100.0080	P 80	50	3100.0400	P 400	100
3100.0120	P 120	100	3100.0500	P 500	100
3100.0150	P 150	100	3100.0600	P 600	100
3100.0180	P 180	100	3100.0800	P 800	100
3100.0220	P 220	100	3100.1000	P 1000	100
3100.0240	P 240	100	3100.1500	P 1500	100
3100.0280	P 280	100			

150 mm, Velcro, 9-Loch

3105



6 inch, Velcro, 9-hole

Beschreibung: Spezialschleifmittel für die professionelle Anwendung in Autolackierereien. Für Grob-, Zwischen- und Endschliff. Sehr gute Standzeit und exzellentes Finish. Kletthaftend.

Description: Special abrasive, designed for use in body and paint shops. For coarse, interim and final sanding. Long life and excellent finish. Velcro backing.

Art.-Nr. Part.-No.	Körnung Grit	VE/Stück Units
3105.0060	P 60	50
3105.0080	P 80	50
3105.0120	P 120	100
3105.0150	P 150	100
3105.0180	P 180	100
3105.0220	P 220	100
3105.0240	P 240	100
3105.0320	P 320	100
3105.0360	P 360	100
3105.0400	P 400	100
3105.0500	P 500	100
3105.0600	P 600	100
3105.0800	P 800	100
3105.1000	P 1000	100
3105.1500	P 1500	100

70 x 425 mm, Velcro, ungelocht

3110



2 x 16 inch, Velcro, no hole

Beschreibung: Schleifstreifen zum großflächigen Planschleifen von Polyesterspachtel sowie zum Vorschleifen von Füllermaterialien. Kletthaftend.

Description: Velcro backed long board paper.

Art.-Nr. Part.-No.	Körnung Grit	VE/Stück Units
3110.0040	P 40	50
3110.0060	P 60	50
3110.0080	P 80	50
3110.0120	P 120	100
3110.0180	P 180	100
3110.0240	P 240	100
3110.0320	P 320	100
3110.0400	P 400	100
3110.0500	P 500	100

70 x 425 mm, Velcro, 14-Loch

3115



2 x 16 inch, Velcro, 14-hole

Beschreibung: Schleifstreifen zum großflächigen Planschleifen von Polyesterspachtel sowie zum Vorschleifen von Füllermaterialien. Kletthaftend.

Description: Velcro-backed vacuum-assist longboard paper.

Art.-Nr. Part.-No.	Körnung Grit	VE/Stück Units
3115.0040	P 40	50
3115.0060	P 60	50
3115.0080	P 80	50
3115.0120	P 120	100
3115.0180	P 180	100
3115.0240	P 240	100
3115.0320	P 320	100
3115.0400	P 400	100
3115.0500	P 500	100

115 x 280 mm

3120



4 x 11 inch

Beschreibung: Schleifbogen für die professionelle Anwendung in Autolackierereien. Zum Grob- und Zwischenschliff. Manuell oder mit Schwingschleifer zu verarbeiten.

Description: Special abrasive, designed for use in body and paint shops. For coarse and interim sanding.

Art.-Nr. Part.-No.	Körnung Grit	VE/Stück Units
3120.0040	P 40	50
3120.0060	P 60	50
3120.0080	P 80	50
3120.0120	P 120	100
3120.0150	P 150	50
3120.0180	P 180	50
3120.0240	P 240	50
3120.0320	P 320	50

Art.-Nr. Part.-No.	Körnung Grit	VE/Stück Units
3130.0040	P 40	50
3130.0060	P 60	50
3130.0080	P 80	50
3130.0120	P 120	100
3130.0150	P 150	100
3130.0180	P 180	100
3130.0220	P 220	100
3130.0240	P 240	100
3130.0280	P 280	100
3130.0320	P 320	100

4 x 9 inch, Velcro, 10-hole

Beschreibung: Schleifbogen zum großflächigen Planschleifen von Polyesterspachtel sowie zum Vorschleifen von Füllermaterialien. Kletthaftend.

Description: Special abrasive, designed for use in body and paint shops. For coarse and interim sanding. Velcro backing.



115 x 230 mm, Velcro, 10-Loch

3130

Art.-Nr. Part.-No.	Körnung Grit	VE/Stück Units
3140.0040	P 40	50
3140.0060	P 60	50
3140.0080	P 80	50
3140.0120	P 120	100
3140.0150	P 150	100
3140.0180	P 180	100
3140.0220	P 220	100
3140.0240	P 240	100
3140.0280	P 280	100
3140.0320	P 320	100
3140.0360	P 360	100
3140.0400	P 400	100
3140.0500	P 500	100

2 x 7 inch, Velcro, 8-hole

Beschreibung: Schleifbogen zum großflächigen Planschleifen von Polyesterspachtel sowie zum Vorschleifen von Füllermaterialien. Kletthaftend.

Description: Special abrasive, designed for use in body and paint shops. For coarse and interim sanding. Velcro backing.



70 x 198 mm, Velcro, 8-Loch

3140

Art.-Nr. Part.-No.	Körnung Grit	VE/Stück Units
3150.0150	P 150	5
3150.0180	P 180	5
3150.0240	P 240	5
3150.0280	P 280	5
3150.0320	P 320	5
3150.0360	P 360	5
3150.0400	P 400	5
3150.0500	P 500	5
3150.0600	P 600	5
3150.0800	P 800	5

Flex 4 inch x 28 yd

Beschreibung: Spezialschleifmittel für die professionelle Anwendung in Autolackierereien. Zum manuellen Nachschleifen von Sicken, Falzen und schwer zugänglichen Stellen. Perforiert.

Description: Soft-backed, perforated continuous roll. For the manual re-sanding of details difficult to access. The foam provides even pressure, which reduces the risk of sanding through the surface.



115 mm x 25 m FLEX

3150

Art.-Nr. Part.-No.	Körnung Grit	VE/Stück Units
3155.0150	P 150	5
3155.0180	P 180	5
3155.0240	P 240	5
3155.0280	P 280	5
3155.0320	P 320	5
3155.0360	P 360	5
3155.0400	P 400	5
3155.0500	P 500	5
3155.0600	P 600	5
3155.0800	P 800	5

Flex 4 inch x 28 yd anti-slip

Beschreibung: Spezialschleifmittel für die professionelle Anwendung in Autolackierereien. Zum manuellen Nachschleifen von Sicken, Falzen und schwer zugänglichen Stellen. Perforiert. Erleichterte Anwendung durch rutschfestem Schaum.

Description: Soft-backed, perforated continuous roll. For the manual re-sanding of details difficult to access. The foam provides even pressure, which reduces the risk of sanding through the surface. Perfect application due to new anti-slip foam.



115 mm x 25 m FLEX anti-slip

3155 NEW

Art.-Nr. Part.-No.	Körnung Grit	VE/Stück Units
3160.0040	P 40	1
3160.0060	P 60	1
3160.0080	P 80	1
3160.0120	P 120	1
3160.0150	P 150	1
3160.0180	P 180	1
3160.0220	P 220	1
3160.0240	P 240	1
3160.0320	P 320	1
3160.0400	P 400	1

4 inch x 55 yd

Beschreibung: Schleifrolle für die professionelle Anwendung in Autolackierereien. Zum Grob- und Zwischenschliff.

Description: Cloth-backed continuous roll. For coarse and interim sanding. Easy to tear.



115 mm x 50 m

3160

Art.-Nr. Part.-No.	Körnung Grit	VE/Stück Units
3350.0080	P 80	50
3350.0120	P 120	100
3350.0150	P 150	100
3350.0180	P 180	100
3350.0220	P 220	100
3350.0240	P 240	100
3350.0280	P 280	100
3350.0320	P 320	100
3350.0360	P 360	100
3350.0400	P 400	100
3350.0500	P 500	100
3350.0600	P 600	100
3350.0800	P 800	100
3350.1000	P 1000	100
3350.1500	P 1500	100
3350.2000	P 2000	100

Trillanium 6 inch, Velcro, 21-hole

Beschreibung: Hochleistungsschleifmittel auf Folienträger für die professionelle Anwendung in Autolackierereien. Außergewöhnlich hohe Standzeit. Exzellentes Finish.

Description: High-performance abrasive on foil medium for the professional paint shop. Extraordinary long tool life. Excellent Finish.



150 mm, Velcro, 21-Loch, Trillanium

3350

75 mm, Velcro, Trillanium

3351



Trillanium 3 inch, Velcro

Beschreibung: Hochleistungsschleifmittel auf Folienträger für die professionelle Anwendung in Autolackierereien. Außergewöhnlich hohe Standzeit. Exzellentes Finish.

Description: High-performance abrasive on foil medium for the professional paint shop. Extraordinary long tool life. Excellent Finish.

Art.-Nr. Part.-No.	Körnung Grit	VE/Stück Units
3351.0080	P 80	50
3351.0120	P 120	50
3351.0180	P 180	50
3351.0220	P 220	50
3351.0240	P 240	50
3351.0280	P 280	50
3351.0320	P 320	50
3351.0360	P 360	50
3351.0400	P 400	50
3351.0500	P 500	50
3351.0600	P 600	50
3351.0800	P 800	50
3351.1000	P 1000	50
3351.1200	P 1200	50
3351.1500	P 1500	50

70 x 420 mm, Velcro, 14-Loch, Trillanium

3353

NEW



Trillanium 2 x 16 inch, 14-hole

Beschreibung: Hochleistungsschleifmittel auf Folienträger zum großflächigen Planschleifen von Polyesterspachtel sowie zum Vorschleifen von Füllermaterialien. Kletttaftend. Außergewöhnlich hohe Standzeit.

Description: High-performance abrasive on foil medium. Velcro backing.

Art.-Nr. Part.-No.	Körnung Grit	VE/Stück Units
3353.0080	P 80	50
3353.0120	P 120	100
3353.0150	P 150	100
3353.0180	P 180	100
3353.0240	P 240	100
3353.0320	P 320	100
3353.0400	P 400	100

115 x 230 mm, Velcro, 10-Loch, Trillanium

3354

NEW



Trillanium 4 x 9 inch, 10-hole

Beschreibung: Hochleistungsschleifmittel auf Folienträger zum großflächigen Planschleifen von Polyesterspachtel sowie zum Vorschleifen von Füllermaterialien. Kletttaftend. Außergewöhnlich hohe Standzeit.

Description: High-performance abrasive on foil medium. Velcro backing.

Art.-Nr. Part.-No.	Körnung Grit	VE/Stück Units
3354.0080	P 80	50
3354.0120	P 120	100
3354.0150	P 150	100
3354.0180	P 180	100
3354.0240	P 240	100
3354.0320	P 320	100
3354.0400	P 400	100

70 x 198 mm, Velcro, 8-Loch, Trillanium

3355

NEW



Trillanium 2 x 7 inch, 8-hole

Beschreibung: Hochleistungsschleifmittel auf Folienträger zum großflächigen Planschleifen von Polyesterspachtel sowie zum Vorschleifen von Füllermaterialien. Kletttaftend. Außergewöhnlich hohe Standzeit.

Description: High-performance abrasive on foil medium. Velcro backing.

Art.-Nr. Part.-No.	Körnung Grit	VE/Stück Units
3355.0080	P 80	50
3355.0120	P 120	100
3355.0150	P 150	100
3355.0180	P 180	100
3355.0220	P 220	100
3355.0240	P 240	100
3355.0320	P 320	100
3355.0360	P 360	100
3355.0400	P 400	100

70 x 125 mm, Velcro, 8-Loch, Trillanium

3356

NEW



Trillanium 2 x 5 inch, 8-hole

Beschreibung: Hochleistungsschleifmittel auf Folienträger zum großflächigen Planschleifen von Polyesterspachtel sowie zum Vorschleifen von Füllermaterialien. Kletttaftend. Außergewöhnlich hohe Standzeit.

Description: High-performance abrasive on foil medium. Velcro backing.

Art.-Nr. Part.-No.	Körnung Grit	VE/Stück Units
3356.0080	P 80	50
3356.0120	P 120	100
3356.0150	P 150	100
3356.0180	P 180	100
3356.0240	P 240	100
3356.0320	P 320	100
3356.0400	P 400	100

Soft Disc Gold, 150 mm, Velcro

3400

NEW



Soft Disc Gold, 6 inch, Velcro

Beschreibung: Innovatives Schleifmittel mit Schaumstoffzwischenlage für die professionelle Anwendung in Autolackierereien. Ausgezeichnete Absaugung durch 21-Loch Stanzung. Hervorragendes Oberflächenfinish.

Description: Innovative abrasive with soft foam for the professional paint shop. The 21-hole punching ensures are perfect dust exhaust. Excellent Finish.

Art.-Nr. Part.-No.	Körnung Grit	VE/Stück Units
3400.0240	P 240	50
3400.0280	P 280	50
3400.0320	P 320	50
3400.0360	P 360	50
3400.0400	P 400	50
3400.0500	P 500	50
3400.0600	P 600	50
3400.0800	P 800	50

Art.-Nr. Part.-No.	Körnung Grit	VE/Stück Units
3500.0220	P 220	50
3500.0240	P 240	50
3500.0280	P 280	50
3500.0360	P 360	50
3500.0400	P 400	50
3500.0500	P 500	50
3500.0600	P 600	50
3500.0800	P 800	50
3500.1000	P 1000	50
3500.1200	P 1200	50
3500.1500	P 1500	50
3500.2000	P 2000	50
3500.2500	P 2500	50

9 x 11 inch Water Proof

Beschreibung: Wasserfestes Schleifpapier zum Schleifen aller Lackmaterialien. Lange Standzeit. Feines Oberflächenfinish.

Description: Waterproof abrasive for sanding all paint materials. Long life. Good finish.

Wasserfest 230 x 280 mm

3500

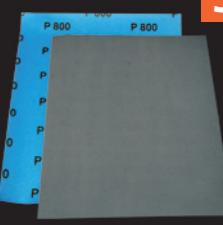

Art.-Nr. Part.-No.	Ausführung Size	VE/Stück Units
3600.0001	medium	20
3600.0002	fine	20
3600.0003	super fine	20
3600.0004	ultra fine	20

Soft Pad 5 x 4 inch

Beschreibung: Schleifmittel auf Schaumstoffunterlage zum manuellen Nachschleifen von Rundungen und schwer zugänglichen Stellen. Hochflexibel mit hoher Anpassungsfähigkeit. Trocken oder nass einsetzbar.

Description: For manual re-sanding of curves and areas difficult to reach. Very flexible. Does not cause any sharp edges. Wet or dry sanding.

Soft Pad 140 x 115 mm

3600



Art.-Nr. Part.-No.	Ausführung Size	VE/Stück Units
3660.0100	100 g	1

Sanding Control Kit

Beschreibung: Kontrollpulver zur Hervorhebung von Fehlstellen in durchgetrockneten Füller- und Primermaterialien. Schnell, einfach, lösemittelfrei.

Description: Quickest and most cost effective system for highlighting imperfections such as pinholes and scratches in filler and primer. Solvent-free.

Schleifkontrollpulver Set

3660

NEW



Art.-Nr. Part.-No.	Farbe Colour	Ausführung Size	VE/Stück Units
3700.0100	schwarz - black	100mm	10
3700.0150	schwarz - black	150mm	10

Clean and Strip Disc

Beschreibung: Reinigungsscheibe zum maschinellen Entfernen von Rost, Steinschlagschutz, Altack, Schweißtropfen, etc. Flexibel mit langer Standzeit.

Description: Cleaning disc for removing rust, paint, protective coatings, etc. down to bare metal. Flexible and long-lasting.

Reinigungsscheibe

3700



Art.-Nr. Part.-No.	Abmessung Size	VE/Stück Units
3706.0013	13mm	10

Mandrel

Beschreibung: Zur Aufnahme von 4CR 3700 und 3705.

Description: Mandrel for 4CR 3700 and 3705.

Spanndorn

3706



Art.-Nr. Part.-No.	Farbe Colour	Abmessung Size	Ausführung Size	VE/Stück Units
3750.0001	rot - red	115mm x 10m	extra fine	5
3750.0002	grau - grey	115mm x 10m	ultra fine	5
3750.0003	gold - gold	115mm x 10m	micro fine	5

Scuff Roll 33 ft

Beschreibung: Schleifvlies zum Mattieren von Karosserieteilen vor dem Lackauftrag. Sehr formanpassungsfähig, besonders an schwer zugänglichen Stellen. Nass oder trocken einsetzbar.

Description: Non-woven material for matting vehicle surfaces before painting. Use wet or dry.

Vlies Rolle

3750



Vlies Pad
3751



Scuff Pad 6 x 9 inch

Art.-Nr. Part.-No. 3751.0001
3751.0002
3751.0003

Farbe Colour rot - red
grau - grey
gold - gold

Abmessung Size 115 x 280mm
115 x 280mm
115 x 280mm

Ausführung Size extra fine
ultra fine
micro fine

VE/Stück Units 20
20
20

Beschreibung: Schleifvlies zum Mattieren von Karosserieteilen vor dem Lackauftrag. Sehr formanpassungsfähig, besonders an schwer zugänglichen Stellen. Nass oder trocken einsetzbar.
Description: Non-woven pads for matting car body parts before painting. Use wet or dry.

Vlies Disc
3752



Scuff Disc 6 inch

Art.-Nr. Part.-No. 3752.0151
3752.0152

Farbe Colour rot - red
grau - grey

Abmessung Size 150mm
150mm

Ausführung Size extra fine
ultra fine

VE/Stück Units 10
10

Beschreibung: Schleifvlies zum Mattieren von Karosserieteilen vor dem Lackauftrag. Sehr formanpassungsfähig, besonders an schwer zugänglichen Stellen. Nass oder trocken einsetzbar.
Description: Non-woven disc for matting large areas before painting. Use wet or dry.

Mattierungsgel
3760



Matting Gel

Art.-Nr. Part.-No. 3760.0575

Ausführung Size 575 g, inkl. Pinsel - incl. brush

VE/Stück Units 6

Beschreibung: Wasserbasierendes Gel zum Reinigen, Mattieren und Entfetten von Karosserie- und Kunststoffteilen in einem Arbeitsgang.
Description: Waterbased gel for cleaning, matting and degreasing in a single operation. For all car body panels and plastic components which can be painted.

Reinigungs- und Mattierpaste
3770



Cleaning and Matting Paste

Art.-Nr. Part.-No. 3770.1000

Gebinde Size 1kg

VE/Stück Units 8

Beschreibung: Schleifpaste für Beilackierungen, die in einem Arbeitsgang von Wachs, Fetten und Silikon reinigt und mattiert.
Description: Sanding paste for spot repair finishes (bledning method). 3770 cleans all traces of wax, grease and silicone and gives in the same time a matted surface, all in one step.

Exzenter
3800



Excenter

Art.-Nr. Part.-No. 3800.0001
3800.0005
3800.0025
3800.0075
3800.0095

Abmessung Size 150mm
150mm
75mm
150mm

Ausführung Size Ersatzteilset - spare part set
5mm Hub - orbit
2,5mm Hub - orbit
2,5mm Hub - orbit
9,5mm Hub - orbit

VE/Stück Units 1
1
1
1
1

Beschreibung: Druckluftbetriebener Einhandexzenter mit Absaugung. Geräuscharm durch Spezialschalldämpfer.
Description: Pneumatic powered excenter for one hand operation. Low noise due to special sound absorber.

Schleifblock Velcro
3801



Sanding Block Velcro

Art.-Nr. Part.-No. 3801.0150

Ausführung Size 150mm

VE/Stück Units 1

Beschreibung: Handschleifblock zur manuellen Verarbeitung von 150 mm klett haftenden Schleifscheiben.
Description: Hand held sanding block for the manual use of 6" velcro sanding discs.

Rubber Sanding Block black
3802



Art.-Nr. Part.-No. 3802.0001

Farbe Colour schwarz - black

Abmessung Size 70 x 125mm

VE/Stück Units 12

Beschreibung: Schleifklotz für Nass- und Trockenschliff.
Description: Rubber sanding block for wet and dry sanding.

Decal Removal Disc
3804



Art.-Nr. Part.-No. 3804.0001

Ausführung Size 2 Stck. + 1 Adapter - 2 pieces + 1 adapter

VE/Stück Units 1

Beschreibung: Zum schnellen, rückstandslosen Entfernen von Folienbeschriftungen, Aufklebern, Zierstreifen, etc., ohne die Lackoberfläche zu beschädigen.
Description: For fast and residue-free removal of decals, stickers, decorative strips, etc., without damaging the paint.

Excenter Back Pad
3805



Art.-Nr. Part.-No. 3805.0007
3805.0073
3805.2101
3805.2102
3805.2103
3805.7921

Abmessung Size 150mm
73mm
150mm
150mm
150mm
150mm

Ausführung Size medium 7 Loch - holes
medium 3 Loch - holes
extra soft 7/9/21 Loch - holes
hard - hard 7/9/21 Loch - holes
long velcro 7/9/21 Loch - holes
medium 7/9/21 Loch - holes

VE/Stück Units 1
1
1
1
1
1

Beschreibung: Universell einsetzbarer Schleifteller für den Grob- bis Endschliff. Für alle handelsüblichen Exzenter schleifer geeignet. 5/16 inch und M8, Velcro.
Description: Back-up pad for vacuum assist, from coarse to final sanding. Suitable for all commercially available orbital sanders. Fits 5/16 inch and M8.

Fileboard Velcro
3806



Art.-Nr. Part.-No. 3806.0400
3806.0414

Abmessung Size 70 x 420mm
70 x 420mm

Ausführung Size ungelocht - no holes
14-Loch - holes

VE/Stück Units 1
1

Beschreibung: Schleifzahn mit Staubabsaugung (bei 14-Loch) für flächiges Planschleifen von Polyesterspachtel.
Description: 2.75 x 16.5 inch sanding file with dust extraction (14-hole).

Sanding Block 10-hole
3807



Art.-Nr. Part.-No. 3807.0115

Abmessung Size 115 x 230mm

VE/Stück Units 1

Beschreibung: Schleifklotz mit Staubabsaugung zum Schleifen großer Spachtelstellen. 10-fach gelocht, Velcro.
Description: Sanding block with dust extraction for sanding large areas of polyester filler, 10-holes, Velcro.

Sanding Block 8-hole
3808



Art.-Nr. Part.-No. 3808.0125
3808.0198

Abmessung Size 70 x 125mm
70 x 198mm

VE/Stück Units 1
1

Beschreibung: Schleifklotz mit Staubabsaugung zum Schleifen von Polyesterspachtelstellen. 8-fach gelocht, Velcro.
Description: Sanding block with dust extraction for sanding large areas of polyester filler, 8-holes, Velcro.

Schleifblock schwarz
3802



Folienradierer
3804



Exzenter Schleifteller
3805



Schleifzahn Velcro
3806





Schleifklotz 10-Loch
3807



Schleifklotz 8-Loch
3808

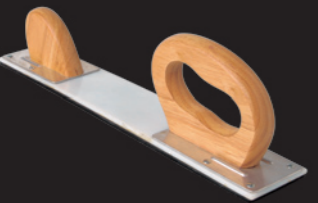

Schleifeile flexibel	Fileboard flexible	Art.-Nr. Part.-No.	Abmessung Size	Ausführung Size	VE/Stück Units
3809 	Beschreibung: Flexible Schleifeile für großflächiges Planschleifen von Polyesterspachtel. Ungelocht. Description: Flexible 2.75 x 16.5 inch fileboard, unperforated.	3809.0400	70 x 400mm	Halteclips - clips	1
Schleifeile Holz	Fileboard wood	Art.-Nr. Part.-No.	Abmessung Size	Ausführung Size	VE/Stück Units
3810 	Beschreibung: Schleifeile für großflächiges Planschleifen von Polyesterspachtel. Ungelocht. Velcro. Description: 2.75 x 16.5 inch fileboard. Easy to handle. Unperforated.	3810.0001	70 x 400mm		1
Interface Pad	Interface Pad	Art.-Nr. Part.-No.	Abmessung Size	Ausführung Size	VE/Stück Units
3820 	Beschreibung: Langlebiger, weicher Schaum zur Verarbeitung von 4CR Schleifmitteln. Erhöht die Formanpassungsfähigkeit und erleichtert dem Anwender die Arbeit an schwer zugänglichen Stellen. Velcro. Description: For use with 4CR sanding discs. Soft foam provides even pressure, which reduces the risk of sanding through the surface. Conformability for sanding areas difficult to access. Velcro backing.	3820.0007 3820.0073 3820.0150	150mm 73mm 150mm	7 Loch - holes 3 Loch - holes 7/9/21 Loch - holes	1 10 1

3350 150 mm, Velcro, 21-Loch, Trillenium Trillenium 6 inch, Velcro, 21-hole

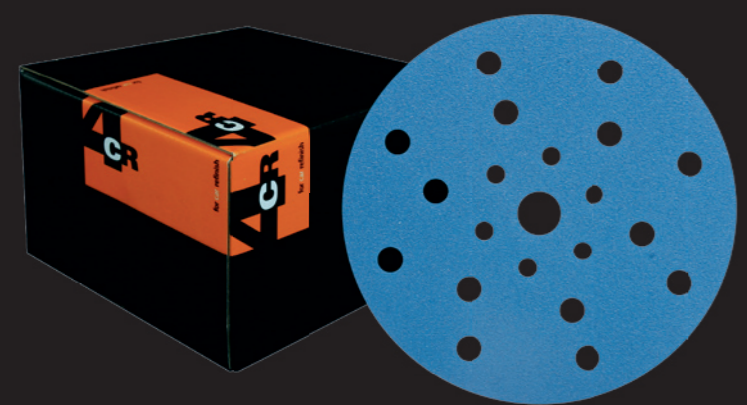

Hochleistungsschleifmittel auf Folienträger für die professionelle Anwendung in Autolackierereien. Außergewöhnlich hohe Standzeit. Exzellentes Finish.

High-performance abrasive on foil medium for the professional paint. Extraordinary long tool life. Excellent Finish.

Füller | Primer



4CR 4210
HS-2K-Füller 4:1 schwarz
 HS-2K-Filler 4:1 black
 HS-2K-Apprêt garnissant 4:1 noir
 HS-2K-филлер 4:1 чёрный
 Art.-Nr. 6.4210.3500
 Inh./Cont.:
e 3,5 Liter

Rostversiegelung

4040 

Rust Sealer

Art.-Nr. Part.-No. 4040.0750

Gebinde Size 750ml

VE/Stück Units 6

Beschreibung: Versiegelt und verfestigt Rostschichten dauerhaft durch Feuchtigkeitsentzug. Sehr gute Tiefenwirkung, schneller und dauerhafter Korrosionsschutz, direkt auf die verrosteten Schichten auftragbar, überlackierbar mit allen handelsüblichen 1K- und 2K-Grundierungen, stoppt auch Zinkkorrosion. Farblos.

Description: Seals and hardens corrosion coats permanently by removing moisture. Adhesion on iron, steel, aluminium and zinc. Colourless.

2K Waschprimer 2:1

4100 

2K Wash Primer 2:1

Art.-Nr. Part.-No. 4100.1000

Gebinde Size 1 ltr

VE/Stück Units 6

Beschreibung: Säurehärtende, chromatfreie 2K Grundierung speziell für Aluminiumuntergründe, mit aktivem Korrosionsschutz und ausgezeichneter Haftung auf Eisen. 4100 kann mit allen 4CR 1K- und 2K-Systemen überlackiert werden. Gelb-grün lasierend.

Description: Acid curing, chromate-free 2K Primer especially developed for aluminium supports, with active protection against corrosion and excellent adhesion to iron. Yellow-green glazing.

2K MS-Füller 5:1

4150 

2K MS-Füller 5:1

Art.-Nr. Part.-No. 4150.1000
4150.5000

Farbe Colour grau - grey
grau - grey

Gebinde Size 1l
5l

VE/Stück Units 6
2

Beschreibung: 2K MS-Füller. Füllstark und schnell schleifbar. Kein Nachsacken und keine Ränderbildung. Verarbeitung nur mit Härter 0041.

Description: Good filling properties and fast sanding times. Non-shrink, non-stain formulation. To be used only with hardener 0041.

2K HS-Füller 4:1 hellgrau

4200 

2K HS-Füller 4:1 light-grey

Art.-Nr. Part.-No. 4200.1000
4200.3500
4200.4000

Farbe Colour hellgrau - light-grey
hellgrau - light-grey
hellgrau - light-grey

Gebinde Size 1l
3,5l
4l

VE/Stück Units 6
4
2

Beschreibung: 4200 kann als Schleiffüller und Nass-in-Nass-Füller verwendet werden. Hervorragende Füllkraft bis 300 µm Trockenfilmdicke. Schnelle Durchtrocknung. Exzellente Schleifbarkeit. Kein Nachsacken und keine Ränderbildung. Verarbeitung mit Härter 0407.

Description: Can be used as sanding filler or wet-on-wet filler. High filling power, fast drying, excellent sanding ability. Can be pigmented up to 25%. Activate with 0407 Universal Hardener. Reduce with 0505 Urethane Reducer.

2K HS-Füller 4:1 dunkelgrau

4205 

2K HS-Füller 4:1 dark-grey

Art.-Nr. Part.-No. 4205.3500

Farbe Colour dunkelgrau - dark-grey

Gebinde Size 3,5l

VE/Stück Units 4

Beschreibung: 4205 kann als Schleiffüller und Nass-in-Nass-Füller verwendet werden. Hervorragende Füllkraft bis 300 µm Trockenfilmdicke. Schnelle Durchtrocknung. Exzellente Schleifbarkeit. Kein Nachsacken und keine Ränderbildung. Verarbeitung mit Härter 0407.

Description: Can be used as sanding filler or wet-on-wet filler. High filling power, fast drying, excellent sanding ability. Can be pigmented up to 25%. Activate with 0407 Universal Hardener. Reduce with 0505 Urethane Reducer.

2K HS-Füller 4:1 schwarz

4210 

2K HS-Füller 4:1 black

Art.-Nr. Part.-No. 4210.1000
4210.3500
4210.4000

Farbe Colour schwarz - black
schwarz - black
schwarz - black

Gebinde Size 1l
3,5l
4l

VE/Stück Units 6
4
2

Beschreibung: 4210 kann als Schleiffüller und Nass-in-Nass-Füller verwendet werden. Hervorragende Füllkraft bis 300 µm Trockenfilmdicke. Schnelle Durchtrocknung. Exzellente Schleifbarkeit. Kein Nachsacken und keine Ränderbildung. Verarbeitung mit Härter 0407.

Description: Can be used as sanding filler or wet-on-wet filler. High filling power, fast drying, excellent sanding ability. Can be pigmented up to 25%. Activate with 0407 Universal Hardener. Reduce with 0505 Urethane Reducer.

2K HS-Füller 4:1 white

Art.-Nr. Part.-No. 4215.1000

Farbe Colour weiß - white

Gebinde Size 1l

VE/Stück Units 6

Beschreibung: 4215 kann als Schleiffüller und Nass-in-Nass-Füller verwendet werden. Hervorragende Füllkraft bis 300 µm Trockenfilmdicke. Schnelle Durchtrocknung. Exzellente Schleifbarkeit. Kein Nachsacken und keine Ränderbildung. Verarbeitung mit Härter 0407.

Description: Can be used as sanding filler or wet-on-wet filler. High filling power, fast drying, excellent sanding ability. Can be pigmented up to 25%. Activate with 0407 Universal Hardener. Reduce with 0505 Urethane Reducer.

2K HS-Füller 4:1 Low VOC

Art.-Nr. Part.-No. 4250.1000
4250.3500

Farbe Colour hellgrau - light-grey
hellgrau - light-grey

Gebinde Size 1l
3,5l

VE/Stück Units 6
4

Beschreibung: Schleiffüller mit hervorragender Füllkraft, schneller Durchtrocknung und exzellenter Schleifbarkeit. Kein Nachsacken. Verarbeitung mit Härter 0408. Erfüllt die VOC-Gesetzgebung in Europa und USA (VOC weniger 420g/l).

Description: Sanding filler in HS-Quality. Chromate-free, high stability and good filling power. Easy sanding. Non-shrink and non-stain formulation. Activate with 0408 Hardener. VOC-compliant product.

2K HS-Füllprimer 4:1

Art.-Nr. Part.-No. 4300.1000

Farbe Colour hellgrau - light-grey

Gebinde Size 1l

VE/Stück Units 6

Beschreibung: 2K-Polyurethan Nass-in-Nass-Füller mit schneller Überlackierbarkeit. Sehr guter Verlauf, kein Nachsacken. Ca. RAL 7035. Verarbeitung mit Härter 0407.

Description: Wet-on-wet-filler with very good stability and overspray absorption. Excellent flow and fast overcoatability. Approx. RAL 7035. Activate with 0407 Universal Hardener.

1K Plastic Primer

Art.-Nr. Part.-No. 4330.1000

Farbe Colour transparent-silber - transparent-silver

Gebinde Size 1l

VE/Stück Units 6

Beschreibung: 1K Haftprimer für die meisten am Auto verwendeten Kunststoffe. Transparent-silber.

Description: Provides a good base for painting plastics. Good filling capabilities for a 1K product.

1K Fillprimer

Art.-Nr. Part.-No. 4350.3000

Farbe Colour grau - grey

Gebinde Size 3l

VE/Stück Units 4

Beschreibung: 1K Füller, schnelltrocknend, füllstark und gut schleifbar. Einsetzbar auf angeschliffenen Altlackierungen und Werksgrundierungen. Nicht VOC-konform innerhalb der EU.

Description: Lacquer based 1K primer sealer. Good filling capabilities for a 1K primer. Not VOC compliant within the EU.

1K WB-Primer

Art.-Nr. Part.-No. 4370.1000

Farbe Colour dunkelgrau - dark-grey

Gebinde Size 1l

VE/Stück Units 6

Beschreibung: Füllstarker 1K Primer auf Wasserbasis mit ausgezeichneter Haftung und sehr gutem Korrosionsschutz. Schnelle Trocknung und sehr gut schleifbar. Ca. RAL 7011.

Description: Waterbased 1K Primer with excellent adhesion and active anticorrosive protection. Easy sanding and fast drying. Recoatable with all common solvent-borne and water-borne 1K and 2K finishing paints. Be used as wet on wet for new parts.

2K HS-Füller 4:1 weiss

4215 

2K HS-Füller 4:1 Low VOC

4250 

2K HS-Füllprimer 4:1

4300 

1K Kunststoff Primer

4330 

1K Fillprimer

4350 

1K WB-Primer

4370 

4CR Füller | Primer

2K Epoxid-Grundierung 2:1

4510

NEW



2K Epoxy Primer 2:1

Beschreibung: Chromatfreie Epoxid-Grundierung für Stahl, Aluminium, Zink und pulverbeschichteten Oberflächen. Hoher Korrosionsschutz. Sehr gute Füllkraft. Sehr gute chemische und mechanische Beständigkeit. Verarbeitung mit Härter 0451.

Description: Chromate free, based on epoxide resin, for efficient paintings of cars and industrial vehicles. Vombines the advantages of a primer/filler and an adhesive primer. High protection against corrosion and excellent adhesion, even on nonferrous metals. Hardener: 0451.

Art.-Nr. Part.-No.
4510.1000

Farbe Colour
hellgrau - light-grey

Gebinde Size
1 l

VE/Stück Units
6

4370

1K WB-Primer dunkelgrau
1K-WB Primer dark-grey



Füllstarker 1K-Primer auf Wasserbasis mit ausgezeichneter Haftung und sehr gutem Korrosionsschutz. Schnelle Trocknung und sehr gut schleifbar.

Waterbased 1K-Primer with excellent adhesion and active anticorrosive protection. Easy sanding and fast drying.

Kleben-Dichten | Bonding-Sealing



5120

4CR CPU Scheibenkleber
1K Direct Glazing Urethane
1K-PU Colle Pare-brise
Sigillante 1K per vetri
Adesivo 1K por parabrisa
Mikrokomponentowy klej do szyb

Art. Nr. 0.5120.0000
Inh./Cont.:
300 ml e

1K PU-Kleb- und Dichtmasse

5100



1K Bond and Seal Polyurethane

Beschreibung: Für elastische Verklebungen von GFK und Metall. Zum Abdichten von Fugen, Nähten und Stößen. Schnelltrocknend und überlackierbar.

Description: For flexible bonding of plastic, fiberglass and metal. For sealing seams and joints. Fast drying and paintable.

Art.-Nr. Part.-No.	Farbe Colour	Ausführung Size	VE/Stück Units
5100.3101	weiß - white	310 ml	12
5100.3102	schwarz - black	310 ml	12
5100.3103	grau - grey	310 ml	12

1K PU-Scheibenkleber

5120



1K-PU Windshield Adhesive

Beschreibung: Hochmoduliger und niederleitfähiger 1K PU-Kleber zum Einkleben von Front-, Heck- und Seitenscheiben. Fahrbereitschaft (bei 23°C und 50% Luftfeuchtigkeit): 2 Stunden ohne Airbag, 8 Stunden mit Airbag. FMVSS 208/212 getestet.

Description: Quick thru-cure 1K Urethane for installing windshields and other stationary glass panels.

Art.-Nr. Part.-No.	Farbe Colour	Ausführung Size	VE/Stück Units
5120.0300	schwarz - black	300 ml	12

Glas Reiniger / Aktivator

5121



Glass Cleaner / Activator

Beschreibung: Reiniger / Aktivator für Glas-/ Keramik-Scheibenkanten und Haftvermittler zum Glas. Zur Anwendung in Verbindung mit 5120 und 5122.

Description: Cleans glass while accelerating the thru-cure of 5120 and 5122.

Art.-Nr. Part.-No.	Ausführung Size	VE/Stück Units
5121.0030	30 ml	25

Glas Primer

5122



Glass Primer

Beschreibung: Klebkraftverstärker mit zusätzlichem UV-Schutz für den Scheibenkleber. Zum Auftrag nach vorheriger Anwendung von 5121.

Description: For prepping glass including UV protection prior to installation with 5120 Adhesive. Apply after use of 5121.

Art.-Nr. Part.-No.	Farbe Colour	Ausführung Size	VE/Stück Units
5122.0030	schwarz - black	30 ml	25

Auftragspinsel

5125



Applicator Brush

Beschreibung: Zur Verarbeitung von 5121, 5122 und 5132.

Description: For applying 5121 and 5122.

Art.-Nr. Part.-No.	VE/Stück Units
5125.0001	100

1K PU-Scheibenkleber 1h

5130



1K PU-Windshield Adhesive 1h

Beschreibung: 5130 wird zur Scheibenverklebung für die Neuverglasung und Reparatur im Fahrzeugbau verwendet. Hochmodulig und niederleitend (keine Kontaktkorrosion). Wegfahrzeiten (23°C/50%rf): ohne Airbag 45 Minuten, mit Doppellairbag 1 Stunde.

Description: Humidity-curing and one component polyurethane adhesive for the directglazing of automotive glasses. Safe-Drive-Away-Time (23°C / 50% rf): without airbags 45 min. and with passenger airbags 1 hour.

Art.-Nr. Part.-No.	Farbe Colour	Gebinde Size	VE/Stück Units
5130.0600	schwarz - black	600ml	20

Art.-Nr. Part.-No.	Farbe Colour	Gebinde Size	VE/Stück Units
5131.0600	schwarz - black	600ml	20

1K PU-Windshield Adhesive 2h

Beschreibung: 5131 wird zur Scheibenverklebung für die Neuverglasung und Reparatur im Fahrzeugbau verwendet. Hochmodulig und niederleitend (keine Kontaktkorrosion). Wegfahrzeiten (23°C/50%rf): ohne Airbag 1 Stunde, mit Doppellairbag 2 Stunden.

Description: Humidity-curing and one component polyurethane adhesive for the directglazing of automotive glasses. Safe-Drive-Away-Time (23°C / 50% rf): without airbags 1 hour and with passenger airbags 2 hours.

1K PU-Scheibenkleber 2h

5131



Art.-Nr. Part.-No.	Gebinde Size	VE/Stück Units
5132.0100	100ml	12

Primer for 5130 and 5131

Beschreibung: One-Step-Primer für die Scheibenverklebung mit Polyurethanen, der die Haftung zwischen Glas/Keramik und dem Scheibenklebstoff sicherstellt und zusätzlich als UV-Schutz dient.

Description: One-Step and solvent containing, physically and chemical drying black primer which promotes the adhesion between the glass / paint surface and the direct glazing adhesive and acts as a UV protection.

Primer für 5130 und 5131

5132



Art.-Nr. Part.-No.	Farbe Colour	Ausführung Size	VE/Stück Units
5150.3101	grau - grey	290 ml	12

Sprayable Seam Sealer

Beschreibung: Spritzbare Nahtabdichtung für Blechüberlappungen und Schweißnähte in Originalstruktur. Schnelltrocknend und überlackierbar.

Description: Sprayable seam sealer for sealing overlapping and welded seams in OEM texture. Fast drying and paintable.

Spritzbare Nahtabdichtung

5150



Art.-Nr. Part.-No.	Gebinde Size	VE/Stück Units
5170.1000	1 kg	6

Brushable Seam Sealer

Beschreibung: Dauerelastische Karosserie-Dichtmasse für Front- und Heckschürzen, Überlappungsnähte im Kofferraum, Fahrgastraum, Radkästen usw. Haftet auf rohem, grundiertem und lackiertem Blech, ist überlackierbar und macht die Nachbildung jeder Struktur möglich.

Description: Durable elastic brushable seam sealer, especially suitable for replicating OEM texture. Adheres to bare metal, primer and painted surfaces and can be topcoated. For use on seams in trunk, passenger area, wheel wells, fenders, spoilers, etc.

Karosserie Dichtmasse

5170



Art.-Nr. Part.-No.	Farbe Colour	Abmessung Size	VE/Stück Units
5175.0910	transparent - transparent	9mm x 10m	10
5175.1210	transparent - transparent	12mm x 10m	10

Seam Sealing Tape

Beschreibung: Flaches Nahtabdichtungsband zum Ersetzen von Dichtungsnähten. Sofort überlackierbar.

Description: A flat seam replacement tape designed to replace door skin seams. Overpaintable immediately. Flexible.

Nahtabdichtungsband

5175



Art.-Nr. Part.-No.	Abmessung Size	VE/Stück Units
5180.0910	9mm x 10m	10
5180.1210	12mm x 10m	10
5180.1910	19mm x 10m	10
5180.2510	25mm x 10m	10

Mounting Tape

Beschreibung: Zur vibrationsfesten Verklebung von Zierstreifen, Emblemen und Randschutzleisten. Hohe Klebkraft.

Description: For vibration resistant bonding of trims, emblems and body mouldings. Standard adhesion.

Doppelseitiges Klebeband

5180



HS Acryl Tape
5185



HS Acrylic Tape

Beschreibung: Doppelseitiges High-Strength Acryl-Klebeband für dauerhafte Verbindungen im Innen- und Außenbereich. Extrem hohe Klebkraft.
Description: Double-sided, high-strength adhesive tape for permanent bonding. For internal and external applications. High adhesion.

Art.-Nr. Part.-No.	Abmessung Size	VE/Stück Units
5185.0610	6mm x 10m	10
5185.0910	9mm x 10m	10
5185.1210	12mm x 10m	10
5185.1910	19mm x 10m	10
5185.2510	25mm x 10m	10

Logo Tape
5190



Logo Tape

Beschreibung: Packung mit 10 Klebestreifen zum Aufkleben von Logos / Emblemen. Für jeden Typ geeignet. Den Schutzstreifen entfernen und das Emblem gut an die Klebeschicht andrücken. Das Emblem erhält die genauen Konturen.
Description: For professional reapplication of vehicle decals. 10 sheets, each 2 x 12 inch.

Art.-Nr. Part.-No.	Abmessung Size	VE/Stück Units
5190.5030	50 x 300mm	10

Türinnenfolie
5195

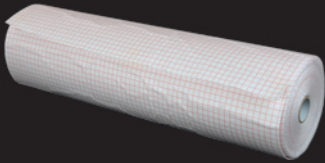

Door Skin Replacement Film

Beschreibung: Selbstklebende Schaumfolie für die Abdichtung von Türinnenseiten. Endlosrolle. Dispenser-Karton.
Description: A replacement film for the inner door skin membrane. Continuous roll. Dispensing pack.

Art.-Nr. Part.-No.	Abmessung Size	VE/Stück Units
5195.6010	60cm x 10m	1

Unterbodenschutz Bitumen
5200



Underbody Protection Bitumen

Beschreibung: Karoserieschutz für die Unterbodenbehandlung aller Fahrzeugarten mit guter Antidröhnwirkung.
Description: Bitumen based underbody corrosion protection for all vehicle types effecting sound deadening.

Art.-Nr. Part.-No.	Farbe Colour	Ausführung Size	VE/Stück Units
5200.0500	schwarz - black	500 ml Spray	12
5200.1000	schwarz - black	1000 ml	12

UBS Bitumen pinselbar
5210



UBC Bitumen brushable

Beschreibung: Karoserieschutz für die Unterbodenbehandlung aller Fahrzeugarten mit guter Antidröhnwirkung. Pinselbar.
Description: When brushwork is preferred. Fully compatible with 5200 UBC effecting sound deadening.

Art.-Nr. Part.-No.	Farbe Colour	Ausführung Size	VE/Stück Units
5210.1000	schwarz - black	1 l	6

Unterbodenschutz Wachs
5250



Underbody Protection Wax

Beschreibung: Karoserieschutz für die Unterbodenbehandlung aller Fahrzeugarten. Gute Haftung auf Metall. Wasserverdrängend.
Description: Underbody protection for all vehicles against corrosion. Excellent adhesion to metal. Effective water displacement.

Art.-Nr. Part.-No.	Farbe Colour	Ausführung Size	VE/Stück Units
5250.0500	schwarz - black	500 ml Spray	12
5250.1000	schwarz - black	1000 ml	12

Cavity Protection brown

Beschreibung: Konservierung für alle Hohlräume im Karosseriebereich. Gute Kriechfähigkeit.
Description: Wax-based corrosion protection that penetrates and flows well into all vehicle cavities.

Art.-Nr. Part.-No.	Farbe Colour	Ausführung Size	VE/Stück Units
5300.0500	braun - brown	500 ml Spray	6
5300.1000	braun - brown	1000 ml	12

Hohlraumkonservierung braun
5300



Cavity Protection white

Beschreibung: Konservierung für alle Hohlräume im Karosseriebereich. Gute Kriechfähigkeit. Tropffrei bis 160°C.
Description: Wax-based corrosion protection that penetrates and flows well into all vehicle cavities. Temperature resistant up to 320°F.

Art.-Nr. Part.-No.	Farbe Colour	Ausführung Size	VE/Stück Units
5350.1000	weiß - white	1000 ml	12

Hohlraumkonservierung weiß
5350



Stone Chip Protection

Beschreibung: Steinschlagschutz für Spoiler, Türen, etc. Kunststoff- Kautschuk-Basis. Schnell-trocknend, dauerelastisch und überlackierbar.
Description: Stone chip protection that allows wet-on-wet painting on spoilers, doors, etc. Fast drying, durable and elastic.

Art.-Nr. Part.-No.	Farbe Colour	Ausführung Size	VE/Stück Units
5400.0501	grau - grey	500 ml Spray - spray	12
5400.0502	schwarz - black	500 ml Spray - spray	12
5400.1001	grau - grey	1000 ml	12
5400.1002	schwarz - black	1000 ml	12
5400.1003	weiß - white	1000 ml	12

Steinschlagschutz
5400



Sound Deadening Boards

Beschreibung: Selbstklebend. Zur Dämmung von Vibrationen und Geräuschen.
Description: Self adhesive boards that can be easily cut to any shape or size. 10 pcs., each 20 x 20 inch.

Art.-Nr. Part.-No.	Abmessung Size	VE/Stück Units
5500.5050	50 x 50cm	10

Antidröhnplatten
5500



2K PU-Plastic Glue 1,5 min.

Beschreibung: Zur schnellen (90 Sek. Topfzeit bei 23°C) Reparatur aller Kunststoffarten. Auch geeignet zur Nachbildung fehlender Kunststoffteile. Überlackierbar. Sehr gute Bohr- und Schleifeigenschaften.
Description: For a fast (pot life 90 sec. (23°C)) repair on damaged plastic parts. Suitable on all kinds of plastic. Overpaintable. Very good workability (drill, sander, etc). Allows rebuilding of missing plastic parts.

Art.-Nr. Part.-No.	Gebinde Size	VE/Stück Units
5625.0050	50ml	10

2K PU-Kunststoffkleber 1,5 Min.
5625



2K PU-Plastic Glue 3,5 min.





Beschreibung: Zur Reparatur aller Kunststoffarten. Auch geeignet zur Nachbildung fehlender Kunststoffteile. Überlackierbar. Sehr gute Bohr- und Schleifeigenschaften. 3,5 Min. Topfzeit bei 23°C.
Description: For repairing damaged plastic parts. Suitable on all kinds of plastic. Overpaintable. Very good workability (drill, sander, etc). Allows rebuilding of missing plastic parts. Pot life: 3,5 min. (23°C).

Art.-Nr. Part.-No.	Gebinde Size	VE/Stück Units
5626.0050	50ml	1

2K PU-Kunststoffkleber 3,5 Min.
5626



<p>Mischdüse</p> <p>5630</p> <p>NEW</p> 	<p>Mixing Tip</p> <p>Beschreibung: Zur Verarbeitung von 50 ml Kleber-Kartuschen.</p> <p>Description: Disposable Mixing Tip for 50 ml cartridges.</p>	<p>Art.-Nr. Part.-No.</p> <p>5630.0050</p>	<p>Ausführung Size</p> <p>50ml</p>	<p>VE/Stück Units</p> <p>10</p>
<p>Verarbeitungspistole</p> <p>5635</p> <p>NEW</p> 	<p>Application Gun</p> <p>Beschreibung: Zur Verarbeitung von 50 ml Kleber-Kartuschen.</p> <p>Description: Manual gun for the application of 50 ml cartridges.</p>	<p>Art.-Nr. Part.-No.</p> <p>5635.0001</p>	<p>Ausführung Size</p> <p>50ml</p>	<p>VE/Stück Units</p> <p>1</p>
<p>Konturfolie</p> <p>5640</p> <p>NEW</p> 	<p>Contouring Tissue</p> <p>Beschreibung: Elastische Folie zum Formen und Glätten des Kunststoffklebers sowie zur Reduzierung der Schleifarbeiten.</p> <p>Description: To be overlaid on the Plastic Glue just after it has been applied. Enables simple shaping of the glue.</p>	<p>Art.-Nr. Part.-No.</p> <p>5640.1236</p>	<p>Abmessung Size</p> <p>12cm x 3,6m</p>	<p>VE/Stück Units</p> <p>1</p>
<p>Armierungsgewebe</p> <p>5645</p> <p>NEW</p> 	<p>Reinforcement Tissue</p> <p>Beschreibung: Selbstklebendes Gittergewebe zur Verstärkung der Verklebung.</p> <p>Description: To be used at the backside of the repair.</p>	<p>Art.-Nr. Part.-No.</p> <p>5645.1236</p>	<p>Abmessung Size</p> <p>12cm x 3,6m</p>	<p>VE/Stück Units</p> <p>1</p>
<p>Kunststoff Primer Spray</p> <p>5650</p> <p>NEW</p> 	<p>Plastic Primer Spray</p> <p>Beschreibung: Haftvermittler für Kunststoffteile. Verbessert die Haftung auf allen zu reparierenden Kunststoffen.</p> <p>Description: Improves the adhesion of structural adhesives on thermoplastic materials such as PMMA, SAN, ABS, PP, PA, TPU, rigid PVC, CA.</p>	<p>Art.-Nr. Part.-No.</p> <p>5650.0200</p>	<p>Gebinde Size</p> <p>200ml</p>	<p>VE/Stück Units</p> <p>6</p>
<p>Kunststoff Reiniger</p> <p>5655</p> <p>NEW</p> 	<p>Plastic Cleaner</p> <p>Beschreibung: Zur Reinigung und Entfettung von Kunststoffen vor Reparaturen bzw. Verklebungen.</p> <p>Description: For cleaning and degreasing plastic parts prior to repairing and bonding. Fast drying.</p>	<p>Art.-Nr. Part.-No.</p> <p>5655.0500</p>	<p>Gebinde Size</p> <p>500ml</p>	<p>VE/Stück Units</p> <p>6</p>

<p>Cartridge Gun</p> <p>Beschreibung: Manuelle Handpresspistole für 290-310 ml Kartuschen.</p> <p>Description: Manual gun for the application of 290 - 310 ml cartridges.</p>	<p>Art.-Nr. Part.-No.</p> <p>5900.0001 5900.0002</p>	<p>Ausführung Size</p> <p>standard premium</p>	<p>VE/Stück Units</p> <p>1 1</p>	<p>Kartuschenpresse</p> <p>5900</p> 
<p>Seam Sealer Gun</p> <p>Beschreibung: Zur Verarbeitung von spritzbarer Nahtabdichtung in verschiedenen Strukturen. Für 300 ml bis 320 ml Plastik- oder Aluminiumkartuschen.</p> <p>Description: For the application of sprayable seam sealers in various structures. For 300 ml up to 320 ml plastic or aluminium cartridges.</p>	<p>Art.-Nr. Part.-No.</p> <p>5910.0001</p>	<p>VE/Stück Units</p> <p>1</p>	<p>Nahtabdichtungspistole</p> <p>5910</p> 	
<p>Stone Chip/CP Spray Gun standard</p> <p>Beschreibung: Professionelle UBS-Pistole für 1-Liter-Gebinde.</p> <p>Description: Professional gun for use with 1-liter stone chip cans. Comes with wax dispersion wand.</p>	<p>Art.-Nr. Part.-No.</p> <p>5900.0001 5900.0002</p>	<p>Ausführung Size</p> <p>standard premium</p>	<p>VE/Stück Units</p> <p>1 1</p>	<p>UBS/HV Pistole standard</p> <p>5920</p> 
<p>Stone Chip/CP Spray Gun premium</p> <p>Beschreibung: Profipistole für Unterbodenschutz und Hohlraumkonservierung. Druckluftbetrieben mit Schnellkupplung. Set mit zwei Saugrohren.</p> <p>Description: Professional gun for underbody protection and cavity protection. Pneumatic with rapid action coupling. Set including two suction pipes.</p>	<p>Art.-Nr. Part.-No.</p> <p>5921.0001 5921.0002 5921.0003</p>	<p>Ausführung Size</p> <p>Set - set Saugrohr - suction pipe Hohlraum Schlauch - extension hose</p>	<p>VE/Stück Units</p> <p>1 1 1</p>	<p>UBS/HV Pistole premium</p> <p>5921</p> 

**1K PU-Scheibenkleber
1K-PU Windshield Adhesive**

5120

Hochmoduliger und niederleitfähiger 1K PU-Kleber zum Einkleben von Front-, Heck- und Seitenscheiben. Fahrbereitschaft (bei 23°C und 50% Luftfeuchtigkeit): 2 Stunden ohne Airbag, 8 Stunden mit Airbag. FMVSS 208/212 getestet.

Quick thru-cure 1K Urethane for installing windshields and other stationary glass panels.



2K Lacke
2K paints

1K Lacke
1K paints

Bitumen
bitumen

Harze
resins

Kleber
glue

PU Schäume
polyurethane
foams



6390 Schutzlotion | Barrier Creme

6390 ist eine silikonfreie Hautschutzsalbe, die bei häufig wechselnden Schadstoffgruppen eingesetzt wird. 6390 hat ein duales Wirkungsprinzip, welches bei nicht klar definierbaren einwirkenden Schadstoffen und die dadurch entstehenden Hautgefährdungen schützend wirkt. 6390 wirkt bei Wasser- und Ölkontakt oder ist für nicht klar definierte Hautgefährdungen geeignet. Die O/W-Emulsion ist frei von Silikonöl und hinterlässt keine Spuren auf Werkstücken oder Werkzeugen. Vor Arbeitsbeginn und nach den Pausen wird 6390 sorgfältig auf die vorher gereinigten Hautpartien aufgetragen (besonders gefährdete Hautbereiche, wie zwischen den Fingern oder im Bereich der Fingernägel). Diese Schutzlotion ist klinisch getestet und enthält nach dem derzeitigen Kenntnisstand keine gefährlichen Stoffe nach EU-Richtlinien.

A silicon-free salve that protects against a wide-variety substances. 6390 penetrates to give a double layer of protection against both water based and petroleum based products. The emulsion leaves no greasy feel or smears, and does not hinder any procedures or contaminate parts or tools. Apply at the beginning of the day and after breaks, working the material especially under finger nails and between the fingers. Clinically tested. Does not contain any known dermatological irritants or contaminants, as classified by the EU.

6.6390.0500 500ml



6400 Handreiniger | Hand Cleaner

6400 ist ein silikonfreier, hautneutraler, pastöser Handreiniger der Spitzenklasse mit sehr starker Reinigungswirkung bei 2K- und 1K- Lacken, Farben, Klebern, Harzen, Bitumen und vielen anderen üblicherweise schwer zu beseitigenden Verschmutzungen. 6400 hat sich durch die speziellen Reibmittel (Polyethylenreißkörper) besonders gut im lack- und farbenverarbeitenden Gewerbe bewährt. Um eine optimale Wirksamkeit des Produktes zu erreichen, sollen die Hände zunächst nicht mit Wasser angefeuchtet werden. Der Schmutz wird mit dem pastösen Handreiniger 6400 verrieben, dann wenig Wasser zugeben und den Waschvorgang fortsetzen. Die Hände gründlich unter fließendem Wasser abwaschen. Dieser Spezialhandreiniger ist klinisch getestet und enthält nach dem derzeitigen Kenntnisstand keine gefährlichen Stoffe nach EU-Richtlinien.

A silicon-free, ph-neutral hand cleaning paste that is extremely effective in removing both 1K and 2K coatings, including color, primer, clearcoat, adhesives, resin, etc. The special scrubbing agent (polyethyleneparticles) easily removes the toughest of materials from painters' hands. Best results are obtained by rubbing the cleaner thoroughly on dry hands before rinsing thoroughly with water. Clinically tested. Does not contain any known dermatological irritants or contaminants, as classified by the EU.

6.6400.1000 1000ml



6410 Pflegelotion | Skin Lotion

6410 ist eine spezielle silikonfreie, feuchtigkeitsspendende (Panthanol und Allantain) Öl- / Wasser-Emulsion und ist speziell für die Pflege beruflich beanspruchter Haut entwickelt worden. 6410 lässt sich leicht einreiben/verstreichen, zieht sehr schnell in die Haut ein und hinterlässt keinen störenden Fettfilm. 6410 hat sich speziell im farben- und lackverarbeitenden Gewerbe bestens bewährt und unterstützt die Behandlung von Abnutzungserscheinungen (Abnutzungsdermatosen) der Haut. Nach Beendigung der Arbeit und nach der Reinigung sollte 6410 regelmäßig angewendet werden. 6410 wirkt entzündungshemmend und beschleunigt die Wundheilung. Diese Pflegelotion ist klinisch getestet und enthält nach dem derzeitigen Kenntnisstand keine gefährlichen Stoffe nach EU-Richtlinien.

A silicone-free, moisturizing emulsion containing Panthanol and Lanolin that is specially suited for professionally challenged skin. 6410 is easy to spread and rub in. It is rapidly absorbed and leaves no greasy film. Tested and proven for use by painters, it is effective in treating skin problems associated with the professional application of coatings. 6410, the final step of the 4CR skin care program, should be used after every hand cleaning. Clinically tested. Does not contain any known dermatological irritants or contaminants, as classified by the EU.

6.6410.0500 500ml

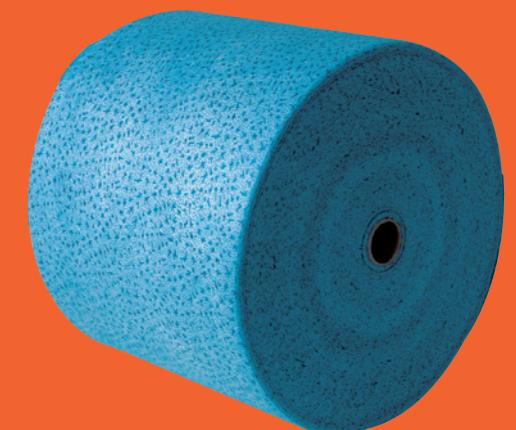

Reinigungstuch ECO

6100



Paper Cleaning Cloth ECO

Art.-Nr. Part.-No. 6100.1000
 Farbe Colour weiß - white
 Abmessung Size 24 x 38cm
 Ausführung Size 1000 Abr. - pcs.
 VE/Stück Units 2

Beschreibung: Standardputztuch für einfache Reinigungsarbeiten.
 Description: Standard cleaning cloth for simple cleaning jobs.

Reinigungstuch weiß 2-lagig

6110



2-ply Cleaning Towel white

Art.-Nr. Part.-No. 6110.1500
 Farbe Colour weiß - white
 Abmessung Size 24 x 38cm
 Ausführung Size 1500 Abr. - pcs.
 VE/Stück Units 2

Beschreibung: Standardputztuch für einfache Reinigungsarbeiten.
 Description: For cleaning and degreasing tools, body panels, etc. Moisture and tear resistant. Absorbent and lint-free.

Reinigungstuch blau 2-lagig

6120



2-ply Cleaning Towel blue

Art.-Nr. Part.-No. 6120.1000
 Farbe Colour blau - blue
 Abmessung Size 38 x 37cm
 Ausführung Size 1000 Abr. - pcs.
 VE/Stück Units 1

Beschreibung: Zum Reinigen und Entfetten von Werkzeugen, Karosserieteilen etc. Nass- und reißfest. Sehr saugfähig und fusselfarm.
 Description: For cleaning and degreasing tools, body panels, etc. Moisture and tear resistant. Absorbent and lint-free.

Reinigungstuch blau 3-lagig

6130



3-ply Cleaning Towel blue

Art.-Nr. Part.-No. 6130.0500
 6130.1000
 Farbe Colour blau - blue
 blau - blue
 Abmessung Size 38 x 37cm
 38 x 37cm
 Ausführung Size 500 Abr. - pcs.
 1000 Abr. - pcs.
 VE/Stück Units 2
 1

Beschreibung: Zum Reinigen und Entfetten von Werkzeugen, Karosserieteilen etc. Nass- und reißfest. Sehr saugfähig und fusselfarm.
 Description: For cleaning and degreasing tools, body panels, etc. Extremely absorbent, tear-resistant and lint-free.

Reinigungstuch lösemittelbeständig

6140



Cleaning Cloth solvent-resistant

Art.-Nr. Part.-No. 6140.1500
 Farbe Colour weiß - white
 Abmessung Size 24 x 38cm
 Ausführung Size 1500 Abr. - pcs.
 VE/Stück Units 2

Beschreibung: Zum Reinigen von Werkzeugen und Lackierpistolen. 100% Zellstoff. Lösemittelbeständig, saugstark, nass- und reißfest.
 Description: For cleaning tools and spray guns. 100% cellulose. Solvent- and tear-resistant, lint-free and absorbent.

Reinigungstuch Multi

6150



Cleaning Cloth Multi

Art.-Nr. Part.-No. 6150.0420
 6150.0500
 Farbe Colour blau - blue
 blau - blue
 Abmessung Size 40 x 42cm
 32 x 38cm
 Ausführung Size 12x35 Stück - pcs.
 500 Abr. - pcs.
 VE/Stück Units 1
 1

Beschreibung: Zur Aufnahme von Lösemitteln, Öl und Schmierstoffen. Sehr saugstark. Lösemittelbeständig und robust.
 Description: High tensile strength towel, for removal of solvents, oil and lubricants. Extremely solvent and tear resistant. Lint-free and highly absorbent.

Degreasing Cloth

Art.-Nr. Part.-No. 6160.0150
 Abmessung Size 38 x 30cm
 Ausführung Size 150 Tücher - cloths

Beschreibung: Kann in Verbindung mit Reinigungsmitteln wie Silikonentferner, Wasser oder wasserbasierenden Reinigungsmitteln genutzt werden. Zeichnet sich durch eine sehr hohe Reißfestigkeit, Reinheit und Fusselfreiheit aus.
 Description: An extremely tough wiper suitable for all cleaning processes in the paint shop. Can be used with all modern water-based and conventional solvent degreasers and silicone-removers. Dispensing box with 150 cloths.

Degreasing Wipe

Art.-Nr. Part.-No. 6170.0050
 Farbe Colour weiß - white
 Abmessung Size 27 x 40cm
 Ausführung Size 4 x 50 Abr. - pcs.
 VE/Stück Units 1

Beschreibung: Set mit Eimer (2,6 L) und 4 Wischtuchrollen. Eimer mit einer Rolle und bis zu 1 L Reinigungsmittel befüllen. Bei geschlossenem Deckel bleiben die Tücher mehrere Monate feucht.
 Description: The wipes are to be put in a bucket, which is to be filled with any kind of solvent or cleaning agent to get a wet cleaning wipe. This dispensing system offers controlled usage and portability. Closed system may reduce solvent consumed and reportable V.O.C.s.

Tack Cloth

Art.-Nr. Part.-No. 6200.0001
 6200.0005
 Abmessung Size 80 x 50cm
 80 x 50cm
 Ausführung Size 1er Pack - single pack
 5er Pack - 5 pieces pack
 VE/Stück Units 100 x 1
 20 x 5

Beschreibung: Zur Aufnahme von Staub vor der Lackierung. Silikonfrei.
 Description: For removing dust prior to painting. Silicone-free.

Tack Cloth soft

Art.-Nr. Part.-No. 6201.0010
 Abmessung Size 17 x 45cm
 Ausführung Size 10er Pack - 10 pieces pack
 VE/Stück Units 10 x 10

Beschreibung: Staubentfernung ohne klebrige Hände. Silikon- und wachsfrei. Auch für wasserlösliche Lacke geeignet. 65 g/qm.
 Description: Pressure sensitive tack. Remove dust without feeling sticky. No need to unfold and ball up cloth. Also works well on water-based coatings. Silicone- and wax-free.

Tack Cloth super wave

Art.-Nr. Part.-No. 6205.0001
 Abmessung Size 80 x 90cm
 Ausführung Size 1er Pack - single pack
 VE/Stück Units 50 x 1

Beschreibung: Die wellenartige Oberflächenstruktur erhöht die Staubaufnahmefähigkeit und eignet sich dadurch hervorragend für große Flächen.
 Description: The wavelike surface structure enjoys almost all the advantages of inexhaustible consumption of dust and is therefore best qualified to clean big surfaces.

Microfiber Wipe green

Art.-Nr. Part.-No. 6250.0001
 Abmessung Size 40 x 40cm
 VE/Stück Units 5

Beschreibung: Sehr hohes Aufnahmevermögen von Schmutz-, Staub- und Fettrückständen aufgrund der speziellen Faserstruktur. Ideal für den Finishbereich. Gewebt mit Spezialrand.
 Description: A fast and effective cleaning cloth with a unique combination of microfibers and knit construction to provide excellent dust, oil and water pickup with minimal linting.

Entfettungstuch

6160



Entfettungsvlies

6170



NEW

Staubbindetuch

6200



Staubbindetuch Soft

6201



Staubbindetuch Super Wave

6205



Mikrofaserstuch grün

6250



Mikrofastertuch Satin

6255

NEW



Microfiber Cloth satin	Art.-Nr. Part.-No. 6255.0001	Abmessung Size 40 x 40cm	VE/Stück Units 2
-------------------------------	--	------------------------------------	----------------------------

Beschreibung: Ultraweicher Floor, extrem saugfähig, 2-seitig, ohne Kettelung, bis 90° waschbar.
Description: Ultrasoft wipe, extremely absorbent, two-sided, washable at 90°.

Reinigungs- und Schutzspray

6260

NEW



Clean and Protect Spray	Art.-Nr. Part.-No. 6260.0750	Gebinde Size 750ml	VE/Stück Units 10
--------------------------------	--	------------------------------	-----------------------------

Beschreibung: Zum schnellen und einfachen Entfernen von Polierrückständen, Fingerabdrücken und Staub von Lackoberflächen. Erzeugt auf der Lack- und anderen Oberflächen hohen Glanz und eine leichte Versiegelung. Silikonfrei.
Description: Developed to remove polish residues, fingermarks and dust from paint surfaces easily and quickly, leaving a high gloss.

Ledertuch

6300



Leather Wipe	Art.-Nr. Part.-No. 6300.0001	Ausführung Size ca. 65 x 42cm	VE/Stück Units 1
---------------------	--	---	----------------------------

Beschreibung: Spezialtuch zum Reinigen und Trockenwischen von Glas, Spiegeln, etc.
Description: Chamois for polishing and cleaning all vehicle surfaces and glass.

Wasserabstreifer

6320



Water Scraper	Art.-Nr. Part.-No. 6320.0300	Abmessung Size 300mm	VE/Stück Units 1
----------------------	--	--------------------------------	----------------------------

Beschreibung: Der gezielt zum Trocknen von Autolacken entwickelte Wasserabstreifer erzeugt 15-mal weniger Reibung als ein herkömmliches Leder. Hochflexibel passt er sich der Karosserieform an.
Description: Supersoft scraper for quick drying of vehicles (or any hard, smooth surface). It works by sweeping water droplets away instantly - leaving surfaces virtually dry and smear-free.

Schutzlotion

6390



Barrier Creme	Art.-Nr. Part.-No. 6390.0500	Gebinde Size 500 ml	VE/Stück Units 12
----------------------	--	-------------------------------	-----------------------------

Beschreibung: Silikonfreie Hautschutzsalbe, die bei häufig wechselnden Schadstoffgruppen eingesetzt wird, d.h. sowohl für den Wasserkontakt als auch für den Ölkontakt oder bei nicht klar definierten Hautgefährdungen geeignet.
Description: Silicone-free barrier cream, suitable for protecting skin against a wide range of contaminants, including water-based and oil-based materials.

Handreiniger

6400



Hand Cleaner	Art.-Nr. Part.-No. 6400.0250 6400.1000 6400.2000	Ausführung Size 250 ml 1000 ml 2000 ml	VE/Stück Units 24 6 6
---------------------	--	--	---------------------------------------

Beschreibung: Klinisch getesteter, lösungsmittelfreier Spezialhandreiniger gegen Lacke, Harze, Kleber, Farben, Bitumen u.ä.
Description: Special hand cleaner for car painters. Clinically tested and solvent-free.

Art.-Nr. Part.-No. 6410.0500	Gebinde Size 500 ml	VE/Stück Units 12
--	-------------------------------	-----------------------------

Skin Lotion

6410



Beschreibung: Silikonfreie, feuchtigkeitsspendende (Panthanol und Allantain) Öl-Wasser-Emulsion. Speziell für die Pflege beruflich beanspruchter Haut entwickelt worden.
Description: Silicone-free moisturizing (Panthanol and Allantain) oil-water-emulsion, specifically developed for the care of professionally skin.

Art.-Nr. Part.-No. 6416.0500 6416.1000 6416.2000	Ausführung Size 500 ml 1000 ml 2000 ml	VE/Stück Units 1 1 1
--	--	--------------------------------------

Manual Pump

6416



Beschreibung: Kunststoffpumpen zur Dosierung von 6390, 6400, 6405 und 6410. Die voreingestellten Produktmengen pro Hubleistung garantieren einen sparsamen Verbrauch.
Description: Plastic pump and wall fastening dispenser for optimal dosage of 6400 and 6405.

Art.-Nr. Part.-No. 6417.0003	Ausführung Size 3er - 3 bottles	VE/Stück Units 1
--	---	----------------------------

Skin Protection - Wall Holder

6417



Beschreibung: Wandhalterung zur Aufbewahrung von 3 bzw. 4 Flaschen aus dem 4CR Hautschutz-Sortiment.
Description: Wall holder for the storage of 3 or 4 bottles of the 4CR skin protection products.

Art.-Nr. Part.-No. 6500.0001 6500.0002 6500.0003	Farbe Colour weiß - white weiß - white weiß - white	Ausführung Size L XL XXL	VE/Stück Units 10 10 10
--	---	--	---

Paint Overall white

6500



Beschreibung: Robuster, atmungsaktiver und antistatischer Overall. Kapuze mit elastischem Bund, Reißverschluss-Abdeckleiste, Taillengummi, Arm- und Beingummi. Kategorie III/CE0516/Typ 5/6.
Description: The coverall is robust, antistatic and breathable. Hood with elastic collar, zipper cover as well as back, arm, and leg elastic. Category III/CE0516/type 5/6

Art.-Nr. Part.-No. 6510.0001 6510.0002 6510.0003	Farbe Colour grau - grey grau - grey grau - grey	Ausführung Size L XL XXL	VE/Stück Units 15 15 15
--	--	--	---

Paint Overall grey

6510



Beschreibung: Der strapazierfähige Overall ist antistatisch ausgerüstet, abriebfest und fusselfrei und schützt zuverlässig vor gesundheitsgefährdenden Feinstäuben. Kapuze mit elastischem Bund, Reißverschluss-Abdeckleiste, Rückengummi, Arm- und Beingummi. Kategorie III/CE 0121/Typ 5.
Description: The robust coverall is antistatic, abrasion-resistant, lint-free, and offers reliable protection against hazardous fine dusts. Hood with elastic band, zipper cover as well as back, arm, and leg elastic. Category III/CE 0121/type 5.

Art.-Nr. Part.-No. 6520.0001 6520.0002 6520.0003 6520.0004	Farbe Colour blau - blue blau - blue blau - blue blau - blue	Ausführung Size M L XL XXL	VE/Stück Units 1 1 1 1
---	---	---	---

Trilobal Paint Overall

6520



Beschreibung: Lackierschutzanzug aus nylonähnlicher Trilobal-Endlosfaser. Antistatisch, fusselfrei, reißfest, waschbar, silikonfrei, atmungsaktiv, lackundurchlässig und flammhemmend.
Description: Made of nylon type continuous Trilobal fiber. Lint free, tear resistant, antistatic, silicone-free, breathable fabric, impermeable to paint and fire resistant.

<p>Lackierschutzanzug Coolfresh</p> <p>6540</p> 	<p>Paint Overall Coolfresh</p> <p>Beschreibung: Speziell für den Lackierer entwickelter Schutzanzug. Allerhöchster Tragekomfort, äußerst atmungsaktiv und wasserabweisend. Antibakterielle Spezialbeschichtung.</p> <p>Description: Developed especially for painter. Highest wearing comfort, extremely breathable and moisture repellent. Special antibacterial coating.</p>	<p>Art.-Nr. Part.-No.</p> <p>6540.0001 6540.0002 6540.0003 6540.0004 6540.0005</p>	<p>Farbe Colour</p> <p>weiß - white weiß - white weiß - white weiß - white weiß - white</p>	<p>Ausführung Size</p> <p>M L XL XXL XXXL</p>	<p>VE/Stück Units</p> <p>1 1 1 1 1</p>
---	---	---	--	--	---

<p>Druckpumpzerstäuber</p> <p>6600</p> 	<p>Pump Spray Bottle</p> <p>Beschreibung: Zur gleichmäßigen konstanten Zerstäubung von Flüssigkeiten. Lösemittelbeständig.</p> <p>Description: For applying liquids in an even and steady stream. Solvent resistant.</p>	<p>Art.-Nr. Part.-No.</p> <p>6600.1000 6600.1001</p>	<p>Ausführung Size</p> <p>1 l Dichtungen-Set - sealing set</p>		<p>VE/Stück Units</p> <p>1 1</p>
--	---	---	---	--	---

<p>Quellschwamm</p> <p>6620</p> 	<p>Squeegie</p> <p>Beschreibung: Quillt im Wasser auf seine eigentliche Größe an. Gute Wasseraufnahme, hohe Abriebfestigkeit, lackschonend.</p> <p>Description: For removing water during sanding and detailing.</p>	<p>Art.-Nr. Part.-No.</p> <p>6620.0001</p>	<p>Abmessung Size</p> <p>ca. 125 x 90 x 35mm</p>		<p>VE/Stück Units</p> <p>10</p>
---	---	---	---	--	--

<p>Reinigungspistole</p> <p>6650</p> 	<p>Cleaning Gun</p> <p>Beschreibung: Geeignet zum Reinigen von z.B. Türeinstiegen und -verkleidungen, Autopolstern, Dachhimmeln, Heizungs- u. Lüftungsschächten, Ersatzteilen und allen schwer zugänglichen Stellen.</p> <p>Description: Suitable for cleaning door sills, cladding, upholstery, roof linings, air vents, replacement parts and all hard-to-reach places.</p>	<p>Art.-Nr. Part.-No.</p> <p>6650.0001</p>	<p>Ausführung Size</p> <p>1 l</p>		<p>VE/Stück Units</p> <p>1</p>
---	--	---	--	--	---------------------------------------

<p>Schaum-Reinigungspistole</p> <p>6655</p> 	<p>Cleaning Foam Gun</p> <p>Beschreibung: Ideal zum Reinigen von stark verschmutzten senkrechten Flächen (LKW-Planen, Hallenwänden), die eine längere Einwirkzeit des Reinigers erfordern.</p> <p>Description: Perfect for cleaning dirty vertical surfaces (canvas covers of trucks, walls of halls), which require a slower flashing, longer working cleaner.</p>	<p>Art.-Nr. Part.-No.</p> <p>6655.0001</p>	<p>Ausführung Size</p> <p>1 l</p>		<p>VE/Stück Units</p> <p>1</p>
--	--	---	--	--	---------------------------------------

<p>Halbmaske</p> <p>6700</p> 	<p>Half Mask</p> <p>Beschreibung: Bequeme und wartungsarme Atemschutz-Halbmaske inkl. 2 Filter A2P3 R D. Speziell für die Schutzanforderungen beim Arbeiten mit Lacken und Farben.</p> <p>Description: Comfortable and low-maintenance half mask incl. 2 filter A2P3 R D. Specially designed for protective requirements in paint shops when working with paint and varnish.</p>	<p>Art.-Nr. Part.-No.</p> <p>6700.0001 6700.0002</p>	<p>Ausführung Size</p> <p>M L</p>		<p>VE/Stück Units</p> <p>1 1</p>
---	---	---	--	--	---

<p>Art.-Nr. Part.-No.</p> <p>6705.0002</p>	<p>Ausführung Size</p> <p>A2P3 R D</p>	<p>VE/Stück Units</p> <p>1 Paar - pair</p>
---	---	---

<p>Art.-Nr. Part.-No.</p> <p>6706.0001</p>	<p>VE/Stück Units</p> <p>40</p>
---	--

<p>Art.-Nr. Part.-No.</p> <p>6707.0001</p>	<p>VE/Stück Units</p> <p>14</p>
---	--

<p>Art.-Nr. Part.-No.</p> <p>6710.0001</p>	<p>Ausführung Size</p> <p>FFP1</p>	<p>VE/Stück Units</p> <p>20</p>
---	---	--

<p>Art.-Nr. Part.-No.</p> <p>6720.0002</p>	<p>Ausführung Size</p> <p>FFP2</p>	<p>VE/Stück Units</p> <p>15</p>
---	---	--

<p>Art.-Nr. Part.-No.</p> <p>6745.0001 6745.0002 6745.0003</p>	<p>Farbe Colour</p> <p>blau - blue blau - blue blau - blue</p>	<p>Ausführung Size</p> <p>M L XL</p>	<p>VE/Stück Units</p> <p>Box à 50 Box à 50 Box à 50</p>
---	---	---	--

<p>Bayonet Filter</p> <p>Beschreibung: Kombinationsfilter A2P3 R D für den Gebrauch mit der Halbmaske 6700. Bajonetverschluss für ein einfaches und sicheres Einsetzen.</p> <p>Description: Combination filter A2P3 R D to use with half mask 6700. Safe and easy bayonet connection.</p> 
--

<p>Prefilter</p> <p>Beschreibung: Grobstaubfilter zum Schutz des Bajonetfilters 6705.</p> <p>Description: Dust filter for additional protection of the bayonet filter 6705.</p> 
--

<p>Prefilter Cover</p> <p>Beschreibung: Haltekappe für den Vorfilter 6706.</p> <p>Description: Cover to hold the prefilter 6706.</p> 

<p>Dust Mask FFP1</p> <p>Beschreibung: Bietet Schutz der Klasse FFP1 gemäß EN149:2001. Arbeiten mit ungiftigen Stäuben und Aerosolen bis zum 4fachen MAK.</p> <p>Description: Finedust Filter mask FFP1, approved according to EN 149:2001</p> 

<p>Dust Mask FFP2</p> <p>Beschreibung: Bietet Schutz der Klasse FFP2 gemäß EN149:2001. Arbeiten mit gesundheitsschädlichen und krebserzeugenden Stäuben, Rauch und Aerosolen bis zum 10-fachen MAK.</p> <p>Description: Finedust Filter mask FFP2, approved according to EN 149:2001.</p> 
--

<p>Latex Gloves blue</p> <p>Beschreibung: Ungepuderte Einweghandschuhe aus Latex zum professionellen Gebrauch. Konform mit EN420, EN388, EN374, ASTM D3578.</p> <p>Description: Disposable high protection latex gloves, powder-free. According to EN420, EN388, EN374, ASTM D3578.</p> 
--

6705

6706

6707

6710

6720

6745

Latexhandschuhe ungepudert

6750



Latex Gloves powderfree

Beschreibung: Einweghandschuhe aus hauchdünnem Naturlatex in der praktischen Spenderbox. Sitzen wie eine zweite Haut und halten Ihre Hände trocken, geschützt und sauber. Aus strapazierfähigem Latexmaterial.

Description: Stretchable, natural latex gloves in a handy dispenser box. Fit like your own skin.

Art.-Nr. Part.-No.	Farbe Colour	Ausführung Size	VE/Stück Units
6750.0001	weiß - white	M	Box à 100
6750.0002	weiß - white	L	Box à 100
6750.0003	weiß - white	XL	Box à 100

Latexhandschuhe gepudert

6755



Latex Gloves powdered

Beschreibung: Einweghandschuhe aus hauchdünnem Naturlatex in der praktischen Spenderbox. Sitzen wie eine zweite Haut und halten Ihre Hände trocken, geschützt und sauber. Aus strapazierfähigem Latexmaterial.

Description: Stretchable, natural latex gloves in a handy dispenser box. Fit like your own skin.

Art.-Nr. Part.-No.	Farbe Colour	Ausführung Size	VE/Stück Units
6755.0001	weiß - white	M	Box à 100
6755.0002	weiß - white	L	Box à 100
6755.0003	weiß - white	XL	Box à 100

Nitrilhandschuhe ungepudert

6760



Nitrile Gloves powderfree

Beschreibung: Einweg-Nitrilhandschuhe (keine Latexallergie-Reizstoffe), ungepudert. Überziehen die Hand wie eine zweite Haut ohne einzuengen. Optimales Tastgefühl auch für feinste Arbeiten. Beständig gegen Öle, Fette, Säuren, Laugen und eine Vielzahl weiterer chemischer Substanzen.

Description: Hypoallergenic, unsterilized, non-latex nitrile rubber gloves. Fine dexterity. Resistant against oil, grease, acid, lye and many other chemical substances.

Art.-Nr. Part.-No.	Farbe Colour	Ausführung Size	VE/Stück Units
6760.0001	blau - blue	M	Box à 100
6760.0002	blau - blue	L	Box à 100
6760.0003	blau - blue	XL	Box à 100

Nitrilhandschuhe gepudert

6765



Nitrile Gloves powdered

Beschreibung: Einweg-Nitrilhandschuhe (keine Latexallergie-Reizstoffe), leicht gepudert. Überziehen die Hand wie eine zweite Haut ohne einzuengen. Optimales Tastgefühl auch für feinste Arbeiten. Beständig gegen Öle, Fette, Säuren, Laugen und eine Vielzahl weiterer chemischer Substanzen.

Description: Hypoallergenic, unsterilized, non-latex nitrile rubber gloves. Fine dexterity. Resistant against oil, grease, acid, lye and many other chemical substances.

Art.-Nr. Part.-No.	Farbe Colour	Ausführung Size	VE/Stück Units
6765.0001	blau - blue	M	Box à 100
6765.0002	blau - blue	L	Box à 100
6765.0003	blau - blue	XL	Box à 100

Nylon-Strickhandschuh

6770



Cotton Gloves

Beschreibung: Komfortable Allzweckhandschuhe mit PU-Beschichtung. Atmungsaktiv, sehr gute Trageeigenschaften, hohe Flexibilität, gutes Fingerspitzengefühl, strapazierfähig.

Description: Light, comfortable, all purpose gloves. Protect hands and keep finger marks off refinished parts.

Art.-Nr. Part.-No.	Farbe Colour	Ausführung Size	VE/Stück Units
6770.0008	weiß - white	Gr. 8	1 Paar - pair
6770.0009	weiß - white	Gr. 9	1 Paar - pair
6770.0010	weiß - white	Gr. 10	1 Paar - pair

Nitrilhandschuhe grün

6780



Nitrile Gloves green

Beschreibung: 30 cm, CE Kat. III. EN374 / 388 / 420, Industriequalität. Beständig gegen viele Lösungsmittel und chemische Substanzen auf Ölbasis. Perfekt geeignet für die Arbeit mit Silikonentferner oder Wasch- und Reinigungsverdünnung.

Description: 30 cm, CE cat. III. EN 374/388/420. Industrial quality. Withstands many solvents and chemical liquids based on oil.

Art.-Nr. Part.-No.	Farbe Colour	Ausführung Size	VE/Stück Units
6780.0007	grün - green	Gr. 7	1 Paar - pair
6780.0008	grün - green	Gr. 8	1 Paar - pair
6780.0009	grün - green	Gr. 9	1 Paar - pair
6780.0010	grün - green	Gr. 10	1 Paar - pair
6780.0011	grün - green	Gr. 11	1 Paar - pair

Safety Goggles

6790



Beschreibung: Gemäß DIN EN 166 (Klasse 1). Optisch korrekte einteilige PC-Scheibe. Kratzfeste Beschichtung. 99,9% UV-Schutz. Komfortkissen an Bügelenden. Weiches universell passendes Nasenpolster.

Description: Safety goggles according to DIN EN 166 (class 1). Optically correct one-piece PC lens. Anti-scratch hard coating. 99,9% UV Block-out. Temple tip comfort cushion pads. Soft universal-fit nose bridge. Optimal fit.

Art.-Nr. Part.-No.	Ausführung Size	VE/Stück Units
6790.0001	klar - clear	6
6790.0002	getönt - toned	6

Cleaner for wbs paints

6800



Beschreibung: Wasserlackreiniger für die automatische oder manuelle Reinigung von Wasserlack-Lackierpistolen. Für den Einsatz in Pistolenreinigungsgeräten. Biologisch abbaubar.

Description: Cleaner for automatic and manual cleaning of water-based paint. To be used in spray gun washers. Biodegradable.

Art.-Nr. Part.-No.	Gebinde Size	VE/Stück Units
6800.0020	20ltr	1

Ceiling Filter

6906



Beschreibung: Zur Endfiltration der Zuluft in Lackier- und Farbspritzanlagen. Filterklasse F5 (EUS). Geprüft nach DIN EN 779. Brandschutz nach DIN 53438 (F1). Temperaturbeständig bis 80°C. Silikonfrei und frei von lackschädigenden Substanzen.

Description: High quality, silicone-free and solvent resistant ceiling filter for spray booths. In compliance to filter class EN779 grade F5 (EUS). Self extinguishing in compliance to DIN 53438, F1.

Art.-Nr. Part.-No.	Farbe Colour	Abmessung Size	VE/Stück Units
6906.2020	weiß - white	2 x 20m	1

Floor filter

6907



Beschreibung: Bodenfilter für Lackierkabinen. Die Filter haben eine Dicke von 50-70 mm (Flächengewicht ca. 220-240 g/qm), temperaturbeständig bis max. 180°C, sind silikonfrei, acetonbeständig und unbrennbar nach DIN 4102.

Description: Floor filter for spray booth. Thickness of filter approx. 50-70 mm (basis weight approx. 220-240 g/m²). Temperature resistant up to max. 180°C. Silicone-free, acetone resistant and non-flammable in accordance to DIN 4102.

Art.-Nr. Part.-No.	Farbe Colour	Abmessung Size	VE/Stück Units
6907.1025	grün - green	100cm x 25m	1
6907.1091	grün - green	100cm x 91m	1
6907.1591	grün - green	150cm x 91m	1
6907.5091	grün - green	50cm x 91m	1
6907.6191	grün - green	61cm x 91m	1
6907.7625	grün - green	76cm x 25m	1
6907.7691	grün - green	76cm x 91m	1
6907.8091	grün - green	80cm x 91m	1

Pre Filter

6908



Beschreibung: Vorfilter der Zuluft in Lackier- und Trocknungsanlagen. selbsterlöschend nach DIN 53438, F1. Dicke ca. 22mm. Flächengewicht ca. 200 g/m². Filterklasse EN779. Güteklasse G4 (EU4).

Description: For pre filtration in painting and drying plants. Tested according to EN 779. Fire prevention requirements according to DIN 53438 (F1). Temperature resistant up to 80°C.

Art.-Nr. Part.-No.	Abmessung Size	VE/Stück Units
6908.2021	2,1 x 20m	1

Halbmaske Half Mask

6700



Bequeme und wartungsarme Atemschutz-Halbmaske inkl. 2 Filter A2P3 R D. Speziell für die Schutzanforderungen beim Arbeiten mit Lacken und Farben.

Comfortable and low-maintenance half mask incl. 2 filter A2P3 R D. Specially designed for protective requirements in paint shops when working with paint and varnish.

4CR Kunststofflack Spray

Hochwertiger elastischer Decklack zur direkten Lackierung von Kunststoffteilen oder zum Überlackieren von 4CR Strukturspray mit dem Originalfarbton. Glanzgrad matt.

Spray Paint for Plastic

Top quality elastic finishing paint for direct coating of plastic parts of for overcoating of 4CR Structure Spray (7446) in the original shade. Gloss level: mat.



basaltgrau basalt-grey 6.7447.0405
 dunkelgrau dark grey 6.7447.0404
 graphitgrau graphit grey 6.7447.0403
 mittelgrau medium grey 6.7447.0402
 schwarz black 6.7447.0401

Automarke	Modell	Basaltgrau basalt-grey	Dunkelgrau dark grey	Graphitgrau graphit-grey	Mittelgrau medium grey	Schwarz black
ALFA ROMEO	Alle Modelle					
AUDI	A2					
	A3					
	A4					
	A6					
	A8					
BMW	3 Series *					
	5 Series *					
	Mini *					
CITROEN	Berlingo					
	C5					
	C3					
	C2					
	Xsara					
	Saxo					
FIAT	Punto					
	Stilo					
	Panda					
	Scudo					
	Dublo					
	Mutipla					
	Ducata					
	Bravo *					
Cinquecento						
FORD	Fiesta *					
	Mondeo *					
	Ka					
	Focus					
	Fusion					
	Escort					
	Maverick					
HONDA	CR-V					
	Civic					
	Jazz					
	HR-V					
LAND ROVER	Alle Modelle All models					
MERCEDES	A190					

Automarke	Modell	Basaltgrau basalt-grey	Dunkelgrau dark grey	Graphitgrau graphit-grey	Mittelgrau medium grey	Schwarz black
NISSAN	Almera					
	Interstar					
	Micra					
	Primera					
PEUGEOT	106					
	205					
	206					
	306					
	405					
	406					
	605					
	807					
RENAULT	Laguna					
	Clio					
	Mégane					
	Espace					
	Trafic					
	Scenic					
ROVER	25					
TOYOTA	Corolla					
	Starlet *					
	Avensis					
	Rav 4 *					
VAUXHALL OPEL	Corsa					
	Vectra *					
	Astra *					
	Zafira					
	Meriva					
	Agila					
VOLVO	V40					
	XC90					
	S60					
	S80					
	740					
	V70					
VW	Golf *					
	Polo *					
	Sharan					
	Passat *					
	Touran					

* Bei der Auswahl der Stoßstangenfarbe kann es je nach Baujahr des Fahrzeugs zu Abweichungen kommen.
 * The colour of the bumper may be different depending of the vehicle's year of manufacture.

Lackieren | Painting



Felgensilber Lack | **Silver Wheel Paint**

7035 NEW



Art.-Nr. Part.-No. 7035.1000 Gebinde Size 1ltr VE/Stück Units 6

Beschreibung: 1K Lack für Autofelgen mit guter chemischer und mechanischer Beständigkeit speziell bei Salzwasserbelastung und Steinschlag.
Description: One coat paint for wheel rims. Good chemical and mechanical resistance, especially resistant against salt water and stone-chips.

Reifenlack | **Tire Coat**

7040



Art.-Nr. Part.-No. 7040.1000 Farbe Colour schwarz - black Ausführung Size 1l VE/Stück Units 6

Beschreibung: Speziallack zum Auffrischen von Autoreifen und Gummiteilen sowie für schwarze Beschriftungen.
Description: Restores appearance and flexibility of tires.

Bumper Paint

7045



Art.-Nr. Part.-No. 7045.1001 7045.1002 Farbe Colour grau - grey schwarz - black Ausführung Size 1l 1l VE/Stück Units 6 6

Beschreibung: 1K-Strukturlack für Kunststoffstoßstangen. Rasche Trocknung und leichte Verarbeitbarkeit sowie gute Wetterbeständigkeit zeichnen dieses Produkt aus. Temperaturbeständig bis 70°C.
Description: For restoring OE texture. Fast drying, easy application, good protection against weathering.

2K UHS-AC-Decklack | **2K UHS-AC-Top Coat**

7050 NEW



Art.-Nr. Part.-No. 7050.0010 7050.3000 Gebinde Size 10ltr 3ltr VE/Stück Units 1 4

Beschreibung: Vergilbungsfester Ultra High Solid Fahrzeuglack für die VOC-konforme Ganz- und Teillackierung von LKW, Bussen und Nutzfahrzeugen. Ergiebigkeit, Glanzhaltung, chemischer und mechanischer Beständigkeit. RAL-Farbtöne.
Description: Weather and yellowing resistant Ultra High Solid car enamel especially developed for the VOC-compliant complete or partial painting of commercial vehicles, busses, heavy goods vehicles. RAL colours.

2K MS-Klarlack 2:1 | **2K MS-Clearcoat 2:1**

7100



Art.-Nr. Part.-No. 7100.1000 7100.5000 Ausführung Size 1l 5l VE/Stück Units 6 4

Beschreibung: 2K MS-Klarlack mit UV-Schutz auf Basis hochwertiger Acrylharze. Zu verarbeiten mit Härter 0407. Nicht VOC-konform innerhalb der EU.
Description: 2K MS two-coat Urethane Clear. Fast out of dust. Crystal clear finish. Activate with Universal Hardener 0407. Reduce, if required, with 0505 Urethane Reducer up to 5%. Not VOC compliant within the EU.

2K ECO-Klarlack 2:1 | **2K ECO-Clearcoat 2:1**

7150 NEW



Art.-Nr. Part.-No. 7150.5000 Gebinde Size 5ltr VE/Stück Units 4

Beschreibung: Füllkräftiger Acryl-Klarlack mit UV-Schutz. Hervorragender Glanz und Lackstand bereits nach einem Spritzgang. Hohe Beständigkeit gegen Witterungs- und Umwelteinflüsse, vergilbungsfest, dauerhafte Glanzhaltung. Härter 0041 oder 0407. Nicht VOC-konform innerhalb der EU.
Description: This clearcoat with UV protection can be applied without adding thinner. Excellent gloss and stability of the paint is assured even by one coat application. Activate with 0041 or 0407 hardener. Not VOC compliant within the EU.

2K HS-Clearcoat 2:1

Art.-Nr. Part.-No. 7200.1000 7200.5000 Ausführung Size 1l 5l VE/Stück Units 6 4

Beschreibung: 2K HS-Klarlack mit hervorragendem UV-Schutz und Witterungsstabilität. Beständig gegenüber chemischer und mechanischer Belastung. Zu verarbeiten mit Härter 0407. Nicht VOC-konform innerhalb der EU.
Description: 2K HS clearcoat with tremendous UV-protection and anti weathering effect. Very good properties against chemical and mechanical circumstances. To be used with hardener 0407. Not VOC compliant within the EU.

2K HS-Rapid Clearcoat 3:1

Art.-Nr. Part.-No. 7230.0750 7230.3000 Gebinde Size 750ml 3ltr VE/Stück Units 6 4

Beschreibung: hochwertiger Acryl-Klarlack zur schnellen und rationellen Reparaturlackierung. Nach einer Trocknung von 15 Minuten bei 60°C, können nach Abkühlen die lackierten Teile poliert werden. Eignet sich auch zur PKW-Partielackierung. Zu verarbeiten mit Härter 0408.
Description: VOC-compliant acrylic clearcoat, especially designed for fast high quality repairs. Can be polished after 15 Min. / 140 °F. Also spot-repairs can be done. Excellent gloss and stability against UV-light are assured even by one coat application. Activate with 0408 hardener.

2K HS-Clearcoat 2:1 Low VOC

Art.-Nr. Part.-No. 7250.1000 7250.5000 Ausführung Size 1l 5l VE/Stück Units 6 4

Beschreibung: 2K HS-Klarlack mit hervorragendem UV-Schutz und Witterungsstabilität. Beständig gegenüber chemischer und mechanischer Belastung. Zu verarbeiten mit Härter 0408. Erfüllt die VOC-Gesetzgebung in Europa und USA (VOC kleiner 420g/l).
Description: High-Solid-Acrylic Clearcoat with especially brilliant gloss and optimum flow on solvent and water based basecoats. Activate with 0408 hardener. VOC compliant product.

2K UHS-Clearcoat 2:1 VOC 420

Art.-Nr. Part.-No. 7255.1000 7255.5000 Ausführung Size 1l 5l VE/Stück Units 6 4

Beschreibung: Hochglänzender Ultra-High-Solid Acryl-Klarlack für die Ganz- und Teillackierung von PKW und Nutzfahrzeugen mit besonders brillantem Klarlackstand und optimalem Verlauf auf Lösemittel und Wasserbasislacken. Zu verarbeiten mit Härter 0408. VOC-konform innerhalb der EU.
Description: Ultra High-Solid Clearcoat with optimum flow. Easy to use. High gloss. Fulfills the VOC-prescriptions within the EU. Activate with 0408 hardener.

2K HS-Clearcoat 2:1 Scratch-resistant

Art.-Nr. Part.-No. 7270.1000 7270.5000 Ausführung Size 1l 5l VE/Stück Units 6 4

Beschreibung: 2K HS-Klarlack mit besonders hoher Kratzfestigkeit durch Anwendung der Reflow-Technologie. Hochglänzende, widerstandsfähige Oberflächen. Nur zu verarbeiten mit Härter 0408.
Description: 2K HS-Clearcoat with especially high scratch resistance by reflow-technology. High gloss, excellent resistance, easy application. Activate only with 0408 hardener.

2K HS-Clearcoat 2:1 Nano

Art.-Nr. Part.-No. 7275.1000 Gebinde Size 1l VE/Stück Units 6

Beschreibung: Kratzbeständiger Klarlack auf der Basis von Nanotechnologie. Für die Ganz- und Teillackierung von PKW, Motorrädern, Nutzfahrzeugen und für die Beschichtung hochbeanspruchter Bauteile geeignet. Härter: 0408.
Description: Scratch resistant clearcoat based on nanotechnology. Excellent durability against micro scratches and against chemical products. Excellent flow, brilliant surface. Activate with 0408 hardener.

2K HS-Klarlack 2:1

7200



2K HS-Rapid Klarlack 3:1

7230 NEW



2K HS-Klarlack 2:1 Low VOC

7250



2K UHS-Klarlack 2:1 VOC 420

7255



2K HS-Klarlack 2:1 Kratzfest

7270



2K HS-Klarlack 2:1 Nano

7275 NEW



1K AC-Lack Spray

7400 

NEW

1K AC-Paint Spray

Art.-Nr. Part.-No. Gebinde Size VE/Stück Units

7400.0000 400ml 48

Beschreibung: Hochwertiger Acryl-Lack in Farbtonen nach RAL-Norm. Speziell für Maschinen, Maschinenteile, Werkzeuge, Fahrzeuge, Nutzfahrzeuge, Land- und Baumaschinen u.v.m. Schnelltrocknend, kratz-, stoß- und schlagfest. Hohe Oberflächenhärte, hoher Glanz.

Description: High quality acrylic paint in standard colours according to the RAL-Norm. Specially for machines, machinery parts, tools, vehicles, and many more. Fast drying, scratch and shock resistant.

Profi Primer Spray

7405 

Profi Primer Spray

Art.-Nr. Part.-No. Farbe Colour Ausführung Size VE/Stück Units

7405.0401 7405.0402 rot-braun - red-brown grau - grey 400 ml 400 ml 12 12

Beschreibung: Schnelltrocknende 1K-Korrosionsschutz-Grundierung von hervorragender Qualität. Speziell geeignet als Haftvermittler für kleine Reparatur- und Durchschliffstellen. Schweißbar! Haftet auf Eisen, Stahl, Zink und bei entsprechender Vorbehandlung auf Aluminium. Hoher Korrosionsschutz.

Description: Fast drying self etching primer with active protection against corrosion. Weldable. Professional quality.

Lackiergrundierung Spray

7406 

Paint Primer Spray

Art.-Nr. Part.-No. Farbe Colour Ausführung Size VE/Stück Units

7406.0400 grau - grey 400 ml 6

Beschreibung: Haftgrund vor Lackierarbeiten. Nitro-Kombi-Basis. Schnelltrocknend.

Description: Special primer for repair work on defekt paint or metall surfaces on cars, motor cycles as well as on other vehicles. Fast drying.

Kunststoffprimer Spray

7407 

NEW

Plastic Primer Spray

Art.-Nr. Part.-No. Gebinde Size VE/Stück Units

7407.0400 400ml 12

Beschreibung: Spezial- Haftvermittler für die anschließende Lackierung von Kunststoffteilen. Geeignet für Außenspiegelgehäuse, Spoiler, Stoßstangen, Kunststoffteile am Boden. Auch für Möbel aus Hartkunststoff einsetzbar.

Description: Adhesion promoter for the following coating of plastic parts. Suitable for exterior mirrors, spoilers, bumpers, plastic parts on the flooring. Also suitable for furniture made of hard-plastics.

2K Highspeed AC-Füller Spray

7408 

NEW

2K Highspeed AC-Filler Spray

Art.-Nr. Part.-No. Gebinde Size VE/Stück Units

7408.0400 400ml 6

Beschreibung: Festkörperreicher Kompaktfüller mit sehr gutem Verlauf, hoher Füllkraft und guter Schleifbarkeit. Besonders geeignet für kleine Reparaturstellen, schnell trocknend, überlackierbar mit allen herkömmlichen Lacksystemen.

Description: 2K High solid compact filler with excellent flow, high build and good sandability. Especially suitable for minor repairs, fast drying, overcoatable with all customary paint systems.

2K Highspeed EP-Füller Spray

7409 

NEW

2K Highspeed EP-Filler Spray

Art.-Nr. Part.-No. Gebinde Size VE/Stück Units

7409.0400 400ml 6

Beschreibung: Epoxy-Grundierung mit sehr guten Haftungs- und Korrosionsschutz-Eigenschaften sowie einem optimalen Verlauf. Überlackierbar mit Basislacken, wasserbasierende Basislacken, 2K-Decklacken und 2K-Klarlack. Lösemittelbeständig.

Description: 2K-Epoxy primer-filler with excellent adhesion and corrosion protection. Optimum flow. Can be overcoated with basecoat paints, waterbased basecoats, 2K-top coat paints and 2K-clearcoats. Solvent resistant.

Spray Putty

Art.-Nr. Part.-No. Farbe Colour Ausführung Size VE/Stück Units

7410.0400 grau - grey 400 ml 12

Beschreibung: Zum Ausgleich kleiner Unebenheiten an Fahrzeugen. Schnelltrocknend und schnell schleifbar.

Description: Fast drying aerosol putty.

Zinc Spray

Art.-Nr. Part.-No. Farbe Colour Ausführung Size VE/Stück Units

7415.0400 grau - grey 400 ml 12

Beschreibung: Korrosionsschutz für innenliegende Bleche beim Punktschweißen. Temperaturbeständig bis 490°C gemäß DIN 50976, 53167, 50021 und 53151.

Description: Anti-corrosion protection for bare metal areas. Temperature resistant up to 915°F, according to DIN 50976, 53167, 50021 and 53151.

Aluminium Spray

Art.-Nr. Part.-No. Ausführung Size VE/Stück Units

7416.0400 400 ml 6

Beschreibung: Hochwertiger Korrosionsschutz zur Behandlung von Abgasrohren, Auspuffanlagen, Öfen, usw. Temperaturbeständig bis 600°C.

Description: Anti-corrosion protection for bare metal areas. Temperature resistant up to 750°F.

Rallye Spray

Art.-Nr. Part.-No. Farbe Colour Ausführung Size VE/Stück Units

7420.0401 7420.0402 7420.0403 7420.0404 schwarz matt - black matt schwarz glänzend - gloss black weiß glänzend - gloss white schwarz seidenmatt - black silk-mat 400 ml 400 ml 400 ml 400 ml 6 6 6 6

Beschreibung: Universell einsetzbares Farbspray zum Ausbessern von Schadstellen im Lack oder als Schleifkontrolle. Schnelltrocknend.

Description: Universal spray paint for repairing small imperfections or to be used as a sanding control. Fast drying.

Control Spray

Art.-Nr. Part.-No. Farbe Colour Ausführung Size VE/Stück Units

7422.0400 schwarz - black 400 ml 12

Beschreibung: Erleichtert das Schleifen von Füllern. Als Kontrollfarbe vor dem Spachtel- und Füllerschleif einzusetzen.

Description: Sanding guide, easy to sand and safe for all basecoat and single-stage paints.

Thermo Spray

Art.-Nr. Part.-No. Farbe Colour Ausführung Size VE/Stück Units

7425.0401 7425.0402 schwarz - black silber - silver 400 ml 400 ml 12 12

Beschreibung: Speziallack mit dauerhafter Hitzebeständigkeit bis 800°C und Korrosionsschutz. Speziell geeignet für temperaturbelastete Gegenstände wie Auspuffanlagen, Motorblöcke, Öfen und Grillverkleidungen.

Description: For finishing parts exposed to high heat. Temperature resistant up to 1200°F.

Spritzspachtel

7410 

Zink Spray

7415 

Aluminium Spray

7416 

Rallye Spray

7420 

Kontrollspray

7422 

Thermo Spray

7425 

Felgensilber Spray 7430 	Silver Wheel Spray Beschreibung: Zum Lackieren von Stahlfelgen. Schnelltrocknend. Abriebfest. Description: For painting steel wheel rims. Fast drying. Smooth finish.	Art.-Nr. Part.-No. 7430.0400	Ausführung Size 400 ml	VE/Stück Units 6
---	--	---------------------------------	---------------------------	---------------------

Klarlack Spray 7435 	Clearcoat Spray Beschreibung: Transparentlackierung von Spot Repair Stellen. Schnelltrocknend. Witterungsbeständig. Description: Aerosol clear for spot repair and non-exposed areas. Fast drying. Weather resistant.	Art.-Nr. Part.-No. 7435.0400	Ausführung Size 400 ml	VE/Stück Units 6
---	--	---------------------------------	---------------------------	---------------------

2K Highspeed Klarlack Spray 7437  NEW	2K Highspeed Clearcoat Spray Beschreibung: Schnelltrocknender, hochglänzender Klarlack für 2-Schicht-Lackierungen mit optimalem Verlauf. Hohe Beständigkeit gegenüber allen Witterungseinflüssen, sowie chemischer und mechanischer Belastung. Hoher UV-Schutz, vergilbungsfrei, lichtbeständig. Description: Fast drying, brilliant gloss clearcoat with an excellent flow. Highly resistant against all kinds of weathering, as well as chemical and mechanical load. High UV-protection, non-yellowing, lightfast. Excellent scratch resistance.	Art.-Nr. Part.-No. 7437.0400	Gebinde Size 400ml	VE/Stück Units 6
---	--	---------------------------------	-----------------------	---------------------

Prefill Spray 7440 	Prefill Spray Beschreibung: Vorgefüllte Spraydosen zum nachträglichen Befüllen mit Autolacken. Ersetzt die Spritzpistole. Ohne Stift. Description: Prefilled aerosol spraycans to be filled with carpaint. To be used instead of a spraygun. Without pin.	Art.-Nr. Part.-No. 7440.0400	Ausführung Size 400 ml	VE/Stück Units 12
--	--	---------------------------------	---------------------------	----------------------

2K Prefill Spray 7441  NEW	2K Prefill Spray Beschreibung: Befüllbare 2K Sprühdose. Vorgefüllt mit einer Mischung aus Treibgas und Lösemittel. Topfzeit nach Härterzugabe: mind. 5 – 6 Stunden. Füllmenge (Lackanteil): 50 ml. Description: 2-component fill-in aerosol for 400 ml net content with integrated hardener. Filled with a mixture of propellant and solvent. Pot-life after transferring the hardener: 5 – 6 hours.	Art.-Nr. Part.-No. 7441.0400	Gebinde Size 400ml	VE/Stück Units 6
---	---	---------------------------------	-----------------------	---------------------

WBS Prefill Spray 7442 	WBS Prefill Spray Beschreibung: Vorgebastete Sprühdose zum Befüllen mit wasserbasierenden Lacken. Speziell vorgebastet mit einer Mischung aus FCKW-freien Treibgas und weiteren Hilfsstoffen. Description: Pre-charged aerosol for the filling of water-based paints. Specially pre-charged with a mixture of CFC-free propellant and other additives.	Art.-Nr. Part.-No. 7442.0400	Ausführung Size 400 ml	VE/Stück Units 12
--	---	---------------------------------	---------------------------	----------------------

Art.-Nr. Part.-No. 7445.0401 7445.0402	Farbe Colour grau - grey schwarz - black	Ausführung Size 400 ml 400 ml	VE/Stück Units 12 12
--	--	-------------------------------------	----------------------------

Bumper Spray Beschreibung: Zum Ausbessern kleiner Lackfehlstellen an Stoßstangen. Schnelltrocknend mit spezieller, rauer Oberflächenstruktur. Description: For spot repair on bumpers. Fast drying.	Bumper Paint Spray 7445 
--	---

Art.-Nr. Part.-No. 7446.0401 7446.0402	Farbe Colour transparent - transparent transparent - transparent	Gebinde Size 400ml 400ml	Ausführung Size fein - fine grob - coarse	VE/Stück Units 12 12
--	--	--------------------------------	---	----------------------------

Structure Spray Beschreibung: Strukturierter Speziallack für die anschließende Lackierung von Kunststoffteilen. Besonders geeignet zur Wiederherstellung von Kunststoffteilen an PKW, LKW, Hobby und Industrie. Ohne Kunststoffprimer verarbeitbar. Description: Structured special paint for plastic. Especially suitable for plastic parts used in automotive industry, hobby and industry. To be applied without plastic primer.	Strukturspray 7446  NEW
--	--

Art.-Nr. Part.-No. 7447.0401 7447.0402 7447.0403 7447.0404 7447.0405	Farbe Colour schwarz - black mittelgrau - medium grey graphitgrau - graphit grey dunkelgrau - dark-grey basaltgrau - basalt grey	Gebinde Size 400ml 400ml 400ml 400ml 400ml	VE/Stück Units 6 6 6 6 6
---	---	---	---

Spray Paint for Plastic Beschreibung: Elastischer Decklack zur direkten Lackierung von Kunststoffteilen oder zum Überlackieren von 4CR Strukturspray mit dem Originalfarbton. Description: Elastic finishing paint for direct coating of plastic parts or for overcoating of 4CR Structure Spray in the original shade. Weitere Informationen siehe Seite 46. Further informations at page 46.	Kunststofflack Spray 7447  NEW
---	--

Art.-Nr. Part.-No. 7450.0400	Ausführung Size 400 ml	VE/Stück Units 6
---------------------------------	---------------------------	---------------------

Cockpit Spray Beschreibung: Zum Pflegen und Reinigen von Kunststoff- und Gummioberflächen in Fahrzeuginnenräumen. Description: For cleaning and maintenance of plastic and rubber surfaces inside vehicles. Body shop safe.	Cockpit Spray 7450 
--	--

Art.-Nr. Part.-No. 7460.0400	Farbe Colour transparent - transparent	Gebinde Size 400ml	VE/Stück Units 12
---------------------------------	---	-----------------------	----------------------

2K Fade-out-thinner Spray Beschreibung: Spezielle Lösemittelmischung zur Vorbehandlung bei Beilackierungen durch Anlösen der Altlackierung. Zur Auflösung von Spritznebelrändern bei Punktausbesserungen oder Beilackierungen. Die Übergangszonen können anschließend problemlos auf Hochglanz poliert werden. Description: Solvent-based mixture for the dissolution of spray-dust on spot-repairs or blending work. The transition zone can be easily polished to achieve a brilliant shine.	2K Löser Spray 7460  NEW
---	---

Art.-Nr. Part.-No. 7480.0400	Ausführung Size 400 ml	VE/Stück Units 12
---------------------------------	---------------------------	----------------------

Spray Adhesive Beschreibung: Klebemittel sowohl für dauerhafte als auch für vorübergehende Haftung. Geeignet zum Verleimen von Papier, Karton, Holz, Textilien und verschiedenen Kunststoffen. Description: Excellent for adhering materials on vehicle interior.	Klebespray 7480 
--	---

Kupfer Spray	Copper Spray	Art.-Nr. Part.-No. 7490.0400	Ausführung Size 400 ml	VE/Stück Units 12
---------------------	---------------------	--	----------------------------------	-----------------------------

7490



Beschreibung: Spray mit einem hohen Kupfergehalt zum Schmieren von Schraubenverbindungen und Lagerpunkten, die sehr hohen Temperaturen ausgesetzt sein können. Temperaturbeständig von -40°C bis + 1.100°C.

Description: Fat with high copper content. Excellent resistance to water, salt, weak acids and lyes. Suitable for lubricating battery contacts, brakes, hinges, clutches and screwings, and also for thermally highly stressed parts such as exhaust connections and fastenings.

Art.-Nr. Part.-No. 7580.0001	VE/Stück Units 750
--	------------------------------

Sprayout Card metal

Beschreibung: Vorgrundierte Metallkarten zum Prüfen der Deckkraft aller Lacksysteme.

Description: Pre-primed metal cards for measuring coverage.

Deckkraftprüfkarte Metall

7580



Pinselflaschen 20ml	Touch-up Bottles 20ml	Art.-Nr. Part.-No. 7500.1000	Ausführung Size 20 ml	VE/Stück Units 1 x 100
----------------------------	------------------------------	--	---------------------------------	----------------------------------

7500



Beschreibung: Zum Abfüllen von Lacken für kleine Reparaturen. Lösungsmittelbeständig. Inkl. Mischkugel und Abstreifer.

Description: Solvent resistant. Perfect dosage to fill in paint for small repairs.

Art.-Nr. Part.-No. 7590.0001	VE/Stück Units 250
--	------------------------------

Sprayout Card paper

Beschreibung: Zum Prüfen der Deckkraft aller Lacksysteme.

Description: For measuring the coverage of all paints.

Deckkraftprüfkarte Papier

7590



Pinselflaschen 50ml	Touch-up Bottles 50ml	Art.-Nr. Part.-No. 7510.0050	Ausführung Size 50 ml	VE/Stück Units 60
----------------------------	------------------------------	--	---------------------------------	-----------------------------

7510



Beschreibung: Zum Abfüllen von Lacken für kleine Reparaturen. Lösungsmittelbeständig. Inkl. Mischkugel.

Description: Solvent resistant. Perfect dosage to fill in paint for small repairs. Incl. mix-bearing.

Art.-Nr. Part.-No. 7595.0001	VE/Stück Units 1
--	----------------------------

Magnetic Stand for Sprayout Cards

Beschreibung: Stativ mit Magnethalter zum Spritzen der Deckkraftprüfkarten Metall, ohne dass ein Kontakt mit den Händen nötig ist.

Description: Keeps cards cleaner, allows easy comparison.

Magnethalter + Stativ

7595



Lacknasenentferner	Run Razor	Art.-Nr. Part.-No. 7530.0001 7530.0002	Ausführung Size gerade - straight gerundet - rounded	VE/Stück Units 1 1
---------------------------	------------------	---	---	---------------------------------

7530



Beschreibung: Feile aus Hartmetall zum Entfernen von Lacknasen auf trockenem Lack mit einer nur minimalen Lackbeschädigung.

Description: Removes quickly and professionally paint runs. Reduces process time and the size of the repair.

Art.-Nr. Part.-No. 7600.0125 7600.0190	Ausführung Size 125 µm 190 µm	VE/Stück Units 1000 1000
---	--	---------------------------------------

Paint Strainer

Beschreibung: Einweg-Nylon-Farbsieb zum Filtern von Lacken und Farben.

Description: Disposable Nylon strainer for filtering paints.

Farbsieb

7600



Retuschierstäbchen	Touch-up Tips	Art.-Nr. Part.-No. 7540.0100	VE/Stück Units 1 x 100
---------------------------	----------------------	--	----------------------------------

7540



Beschreibung: Zur punktgenauen Retuschierung von kleinen Lackschäden.

Description: For small, accurate touch-up work, 100pcs.

Art.-Nr. Part.-No. 7620.0010	Ausführung Size 230 µm	VE/Stück Units 10
--	----------------------------------	-----------------------------

Spray Gun Filter

Beschreibung: Lacksiebe für Fließbecherpistolen zur Vermeidung von Partikeleinschlüssen.

Description: Gravity feed gun filter for many different guns. 275 micron mesh.

Spritzpistolensieb

7620



Flusennadelsatz	Dust Pick Needle Kit	Art.-Nr. Part.-No. 7550.0001 7550.0010	Ausführung Size Set - set Ersatznadeln - replacement needles	VE/Stück Units 1 10
------------------------	-----------------------------	---	---	----------------------------------

7550



Beschreibung: Flusennadelsatz bestehend aus einem Spanndorn und 10 separat verpackten Nadeln, die mit mikroskopisch kleinen Häkchen versehen sind. Zum Entfernen von Staub auf frischen Lackierungen.

Description: For removing particles out of fresh paint. Kit consists of mandrel and ten individually packaged needles which have microscopic hooks at the tip.

Art.-Nr. Part.-No. 7650.0020 7650.0029	Ausführung Size 20cm 29cm	VE/Stück Units 500 250
---	--	-------------------------------------

Stir Stick

Beschreibung: Zum schnellen Mischen aller dünnflüssigen und verlaufenden Materialien.

Description: Baffle design assures thorough mixing of materials.

Rührstab

7650



Messstab
7655



Art.-Nr. Part.-No.	Ausführung Size	VE/Stück Units
7655.0001	2:1 / 4:1	1

Beschreibung: Aluminium Rühr- und Messstab zum Einstellen diverser Lackmaterialien.
Description: Aluminium measuring stick for all mixing ratio.

Mischbecher
7700



Art.-Nr. Part.-No.	Ausführung Size	VE/Stück Units
7700.1401	1,4 l Becher - cup	200
7700.1402	1,4 l Deckel - lid	200
7700.2301	2,3 l Becher - cup	100
7700.2302	2,3 l Deckel - lid	100
7700.3851	0,385 l Becher - cup	200
7700.3852	0,385 l Deckel - lid	200
7700.7501	0,75 l Becher - cup	200
7700.7502	0,75 l Deckel - lid	200

Beschreibung: Einwegmischbecher zum Anmischen und Aufbewahren aller Lackmaterialien, inkl. Mischskala.
Description: Reusable mixing cups for mixing and storage of all coatings. Easy reading of ratio scale.

Becherspender
7705



Art.-Nr. Part.-No.	Ausführung Size	VE/Stück Units
7705.0001	Set - set	1
7705.0750	Becherspender - Mixing cup dispenser 0,75 l	1

Beschreibung: Hochwertige Spender für 4CR Mischbecher.
Description: High-quality dispenser for 4CR mixing cups.

Easy LVS Deckel
7707



Art.-Nr. Part.-No.	Ausführung Size	VE/Stück Units
7707.0385	0,385 l	100
7707.0750	0,75 l	100

Beschreibung: Misch- und Fließbecher in Einem. Der Becher wird durch den Deckel hindurch automatisch belüftet. Das System passt ohne Adapter auf alle 4CR und viele andere Lackierpistolen.
Description: Mixing and gravity cup all in one. The cup is automatically aerated through the lid. Without needing an adapter, it fits all 4CR and many other spray guns.

Easy LVS Flachsieb
7708



Art.-Nr. Part.-No.	Farbe Colour	Ausführung Size	VE/Stück Units
7708.0125	blau - blue	125 µm	100
7708.0200	grün - green	200 µm	100

Beschreibung: Flachsiebe für LVS Deckel. Passend für beide Deckelgrößen.
Description: Flat filter for LVS lids. Fits into both lids.

Easy LVS Adapter
7709



Art.-Nr. Part.-No.	Ausführung Size	VE/Stück Units
7709.0001	DeVilbiss GTiPro	1
7709.0002	SATA (ohne QCC) - (without QCC)	1
7709.0003	Iwata	1
7709.0004	SATA QCC	1
7709.0005	SATA Minijet (ohne QCC) - (without QCC)	1
7709.0006	SATA Minijet QCC	1
7709.0007	DeVilbiss SRIPro	1
7709.0008	Iwata WS400/300 SuperNova	1

Beschreibung: Adapter für LVS Deckel 7707.
Description: Adapter for LVS lid 7707.

Plastic Can
7740



Art.-Nr. Part.-No.	Ausführung Size	VE/Stück Units
7740.0500	500ml	70
7740.1000	1000ml	42

Beschreibung: Leergebinde aus Kunststoff. Inklusive Deckel.
Description: Empty plastic cans, incl. lids.

Metal Can interior painted
7745



Art.-Nr. Part.-No.	Ausführung Size	VE/Stück Units
7745.0250	250ml	250
7745.0500	500ml	192
7745.1000	1000ml	115

Beschreibung: Leergebinde aus innenlackiertem Metall. Inklusive Deckel.
Description: Empty metal cans (interior painted), incl. lids.

Metal Can
7750



Art.-Nr. Part.-No.	Ausführung Size	VE/Stück Units
7750.0010	10ltr	10
7750.0100	100ml	198
7750.0250	250ml	250
7750.0500	500ml	198
7750.1000	1000ml	115
7750.2000	2ltr	44
7750.3000	3ltr	30
7750.5000	5ltr	20

Beschreibung: Leergebinde aus Metall. Inklusive Deckel.
Description: Empty metal cans, incl. lids.

Viscosity Measuring Cup
7760



Art.-Nr. Part.-No.	Ausführung Size	VE/Stück Units
7760.0001	4mm	1

Beschreibung: Für Viskositätsmessungen und Einstellungen von Farben und Lacken nach DIN.
Description: For viscosity measuring and adjusting of paints and lacquers according to DIN.

Cabin Protection
7800



Art.-Nr. Part.-No.	Ausführung Size	VE/Stück Units
7800.0005	5 l	1
7800.0010	10 l	1
7800.0025	25 l	1

Beschreibung: Bindet Staub- und Farbpartikel zuverlässig an Wänden und Decken von Spritzkabinen und verhindert so eine Kontamination der zu lackierenden Oberfläche. Dabei bleibt die klebrige Emulsion transparent und wasserlöslich.
Description: Transparent tacky surface coating for protection of spraybooth walls against dust and overspray.

Cabine Protect peelable
7805





Art.-Nr. Part.-No.	Gebinde Size	VE/Stück Units
7805.0025	25ltr	1

Beschreibung: Abziehlack zum Schutz der Lackierkabine. Schnelltrocknend, filmbildend und wasserlöslich.
Description: White, peelable coating for the protection of spraybooth walls against overspray. Fast drying.

Bodenstaubbindemittel	Dust Control	Art.-Nr. Part.-No.	Ausführung Size	VE/Stück Units
7810 	Beschreibung: Wasserbasierende Flüssigkeit zur Unterdrückung der Staubzirkulation in der Spritzkabine. Wirkung: 5-10 Arbeitstage. Description: Suppressing dust circulation inside a spray booth. Ionizes dust particles to make them drawn together in clusters which makes it too heavy to circulate in the air. Effective: 5 - 10 working days	7810.0005	5l	1
		7810.0010	10l	1
		7810.0030	30l	1

Aquarellpinsel	Water Color Brush	Art.-Nr. Part.-No.	Ausführung Size	VE/Stück Units
7910 	Beschreibung: Reine Kolinsky-Rotmarderhaare, nahtlose Silberzwinge, kurze, maron lackierte Stiele. Description: Pure Kolinsky natural marten hair brushes with seven different sizes to match your design need.	7910.0002	Gr.2	12
		7910.0003	Gr.3	12
		7910.0004	Gr.4	12
		7910.0005	Gr.5	12
		7910.0006	Gr.6	12
		7910.0007	Gr.7	12
		7910.0008	Gr.8	12

Fischpinsel	Oil Brush	Art.-Nr. Part.-No.	Ausführung Size	VE/Stück Units
7920 	Beschreibung: Stumpf, schwarzes Rindshaar, nahtlose Silberzwinge, Holzstiele. Description: Short black bovine hair. In five different sizes to match your design need.	7920.0002	Gr.2	12
		7920.0003	Gr.3	12
		7920.0004	Gr.4	12
		7920.0005	Gr.5	12
		7920.0006	Gr.6	12

Schriftpinsel	Text Brush	Art.-Nr. Part.-No.	Ausführung Size	VE/Stück Units
7930 	Beschreibung: Helle Rindshaare, Nickelzwinge, lange, maron lackierte Stiele. Description: Light bovine bristles, painted brown, for text work, available in four different sizes.	7930.0002	Gr.2	12
		7930.0004	Gr.4	12
		7930.0006	Gr.6	12
		7930.0008	Gr.8	12

Lackier-Ringpinsel	Ring Brush	Art.-Nr. Part.-No.	Ausführung Size	VE/Stück Units
7940 	Beschreibung: Auf Schluss gearbeitet, extravoll, reine Chinaborsten, weißer 2-fach-Kordelverbund, rote Abdeckkappe. Description: Round bristle pattern. Available in four sizes.	7940.0004	Gr.4	12
		7940.0006	Gr.6	12
		7940.0008	Gr.8	12
		7940.0010	Gr.10	12

7707 Easy LVS Deckel Easy LVS Lid



Misch- und Fließbecher in Einem. Der Becher wird durch den Deckel hindurch automatisch belüftet. Das System passt ohne Adapter auf alle 4CR und viele andere Lackierpistolen.

Mixing and gravity cup all in one. The cup is automatically aerated through the lid. Without needing an adapter, it fits all 4CR and many other spray guns.

Polieren | Polishing



Universalpolitur	Universal Polishing Compound	Art.-Nr. Part.-No. 8010.1000	Ausführung Size 1l	VE/Stück Units 6
-------------------------	-------------------------------------	--	------------------------------	----------------------------

8010 

Beschreibung: Ein Produkt für alle Anwendungen. Entfernt Schleifspuren ab Schliiff 2000. Für frische sowie alte Lackierungen geeignet, auch für dunkle Töne. Silikonfrei.

Description: One-step product. Removes 2000 grit scratches. Can be used on fresh and old paints, even dark colors. Silicone-free.

Art.-Nr. Part.-No. 8051.1000	Gebinde Size 1ltr	VE/Stück Units 10
--	-----------------------------	-----------------------------

High Gloss Hand Polish green

Beschreibung: Schützt vor Umwelteinflüssen und schafft einen Hoch- und Tiefenglanz mit lang anhaltender Versiegelung. Einfache und schnelle Anwendung per Hand. Silikonfrei.

Description: A polish for sealing painted surfaces and which you apply by hand. 8051 can be used on any and every paint system, protects the surface and leaves a deep high gloss and long-lasting protection against environmental influences. Silicone-free.

Art.-Nr. Part.-No. 8051.1000	Gebinde Size 1ltr	VE/Stück Units 10
--	-----------------------------	-----------------------------

Hochglanz Handpolitur grün

8051 

NEW

Schleifpaste	Cutting Compound	Art.-Nr. Part.-No. 8020.1000	Ausführung Size 1l	VE/Stück Units 6
---------------------	-------------------------	--	------------------------------	----------------------------

8020 

Beschreibung: Hochwirksame Schleifpaste für die Aufbereitung gealterter sowie für die Bearbeitung frischer Lacke geeignet. Auspolieren von vorgeschliffenen Lackoberflächen ab Schliiff 2000. Silikonfrei.

Description: Cutting and polishing compound for removal of 2000 grit scratches. Can be used on fresh and old paints. Silicone-free.

Art.-Nr. Part.-No. 8052.0500	Gebinde Size 0,5ltr	VE/Stück Units 10
--	-------------------------------	-----------------------------

Antihologram Polish high gloss

Beschreibung: Beseitigt Hologramme dauerhaft und effizient. Besonders geeignet für die Verwendung auf dunklen Farbtönen. Sorgt für einen sichtbaren Tiefenglanz. Silikonfrei.

Description: Removes holograms permanently and efficiently. Especially suitable for application on dark colours. Provides a visible deep high gloss. Silicone-free.

Art.-Nr. Part.-No. 8052.0500	Gebinde Size 0,5ltr	VE/Stück Units 10
--	-------------------------------	-----------------------------

Antihologrammpolitur hochglanz

8052 

NEW

Intensivpolitur	Polishing Compound	Art.-Nr. Part.-No. 8021.1000	Ausführung Size 1l	VE/Stück Units 6
------------------------	---------------------------	--	------------------------------	----------------------------

8021 

Beschreibung: Reinigt den Lack, entfernt Gebrauchsspuren und Lackfehlstellen in nur einem Arbeitsgang und gibt dem Lack einen tiefen, dauerhaften Glanz. Entfernt Schleifspuren ab Schliiff 2000. Silikonfrei.

Description: Polish Compound to be used on fresh repair coatings. Removes 1500 - 2000 grit scratches and wheel marks from 4CR 8020 Cutting Compound. Silicone-free.

Art.-Nr. Part.-No. 8080.0250	Ausführung Size 250 ml Spray - spray	VE/Stück Units 12
--	--	-----------------------------

Restorer

Beschreibung: Zum Auffrischen verblichener Kunststoffteile sowie zum Entfernen von Politurresten. Silikonfrei.

Description: For renovating faded color on plastic parts as well as for removing polish residue. Silicone-free.

Art.-Nr. Part.-No. 8080.0250	Ausführung Size 250 ml Spray - spray	VE/Stück Units 12
--	--	-----------------------------

Farbauffrischer

8080 

Hochglanzpolitur	Finishing Compound	Art.-Nr. Part.-No. 8022.1000	Ausführung Size 1l	VE/Stück Units 6
-------------------------	---------------------------	--	------------------------------	----------------------------

8022 

Beschreibung: Mikrofeine Hochglanzpolitur, entfernt Anschlag der Körnung 2500 in einem Arbeitsgang ohne Hologramme und Mikrokratzer. Hinterlässt einen tiefen, dauerhaften Hochglanz. Silikonfrei.

Description: Removes 2500 grit scratches and produces a high gloss finish. Silicone-free.

Art.-Nr. Part.-No. 8110.0150	Ausführung Size 150 x 50mm	VE/Stück Units 10
--	--------------------------------------	-----------------------------

Polishing Pad white

Beschreibung: Polierschwamm zur maschinellen Verarbeitung von Schleif- und Polierpasten. Fester Schaum, ideal für alle modernen Lacksysteme, Velcro.

Description: Polishing sponge for mechanical use of cutting and polishing compounds. This very firm material is perfect when compounding all modern paints including LVHM.

Art.-Nr. Part.-No. 8110.0150	Ausführung Size 150 x 50mm	VE/Stück Units 10
--	--------------------------------------	-----------------------------

Polierschwamm weiß

8110 

Intensivpolitur KL	Polishing Compound KL	Art.-Nr. Part.-No. 8030.1000	Ausführung Size 1l	VE/Stück Units 6
---------------------------	------------------------------	--	------------------------------	----------------------------

8030 

Beschreibung: Mikrofeine Hochglanzpolitur, entfernt Anschlag der Körnung 2500 in einem Arbeitsgang ohne Hologramme und Mikrokratzer. Hinterlässt einen tiefen, dauerhaften Hochglanz. Speziell auch auf kratzfesten Lacken einsetzbar. Silikonfrei.

Description: Polishing compound, formulated for scratch resistant clear coats.

Art.-Nr. Part.-No. 8120.0080 8120.0150	Ausführung Size 80 x 25mm 150 x 25mm	VE/Stück Units 10 10
---	---	-----------------------------------

Polishing Pad orange

Beschreibung: Universeller Polierschwamm zur maschinellen Verarbeitung von Schleif- und Polierpasten. Fester Schaum, Velcro.

Description: Polishing sponge for mechanical use of cutting and polishing compounds. Stiff Foam.

Art.-Nr. Part.-No. 8120.0080 8120.0150	Ausführung Size 80 x 25mm 150 x 25mm	VE/Stück Units 10 10
---	---	-----------------------------------

Polierschwamm orange

8120 

Universalpolitur Trillanium	Trillanium Universal Polish	Art.-Nr. Part.-No. 8050.1000	Gebinde Size 1ltr	VE/Stück Units 10
------------------------------------	------------------------------------	--	-----------------------------	-----------------------------

8050 

Beschreibung: Als Universalpolitur einzusetzende Schleif- und Hochglanzpolitur auf wasserbasis. Für alle Lacke (auch kratzfeste) geeignet. Silikonfrei.

Description: This universal cutting compound removes marks like nibs, orange peel, scratches, cords, etc. from P1500 upwards. Applicable on any paint surface incl. scratch-resistant, old or newly painted surfaces. Silicone-free.

Art.-Nr. Part.-No. 8130.0150 8130.0160	Ausführung Size 150 x 50mm 160 x 25mm	VE/Stück Units 10 10
---	--	-----------------------------------

Polishing Pad red

Beschreibung: Polierschwamm zur maschinellen Verarbeitung von Schleif- und Polierpasten. Weicher Schaum, Velcro.

Description: Polishing Sponge for mechanical use of cutting and polishing compounds. Designed to allow the free flow of air. Perfect for final polishing. Ultra soft.

Art.-Nr. Part.-No. 8130.0150 8130.0160	Ausführung Size 150 x 50mm 160 x 25mm	VE/Stück Units 10 10
---	--	-----------------------------------

Polierschwamm rot

8130 

<p>Waffle Pad rot</p> <p>8131</p> 	<p>Waffle Pad red</p> <p>Art.-Nr. Part.-No. 8131.0150</p> <p>Ausführung Size 150 x 25mm</p> <p>VE/Stück Units 10</p> <p>Beschreibung: Polierschwamm zur maschinellen Verarbeitung von Schleif- und Polierpasten. Die spezielle Struktur unterstützt optimal die Wirkung der Paste. Weicher Schaum, Velcro.</p> <p>Description: Specifically designed with combs to improve the paste's effects, reducing time.</p>
--	---

<p>Polierschwamm gelb</p> <p>8140</p> 	<p>Polishing Pad yellow</p> <p>Art.-Nr. Part.-No. 8140.0075</p> <p>Ausführung Size 75 x 20mm</p> <p>VE/Stück Units 10</p> <p>Beschreibung: Polierschwamm zur maschinellen Verarbeitung von Schleif- und Polierpasten. Grober, offenerporiger Schaum, besonders für Altlacke geeignet, Velcro.</p> <p>Description: Polishing sponge for mechanical use of cutting and polishing compounds. A coarse open celled foam designed for heavy cutting of oxidised paints.</p>
--	---

<p>Polierschwamm blau</p> <p>8150</p> 	<p>Polishing Pad blue</p> <p>Art.-Nr. Part.-No. 8150.0150</p> <p>Ausführung Size 150 x 50mm</p> <p>VE/Stück Units 10</p> <p>Beschreibung: Polierschwamm zur maschinellen Verarbeitung von Schleif- und Polierpasten. Medium fester Schaum, universell einsetzbar, Velcro.</p> <p>Description: Foam polishing pad for mechanical use of cutting and polishing compounds. An all purpose foam with a medium grade density.</p>
---	---

<p>Polierschwamm blau</p> <p>8151</p> <p>NEW</p> 	<p>Polishing Sponge blue</p> <p>Art.-Nr. Part.-No. 8151.0160</p> <p>Abmessung Size 160mm</p> <p>VE/Stück Units 2</p> <p>Beschreibung: Fester, harter Polierschwamm mit optimierten und scharfkantigen Poren für effektiven Lackabrieb. Zum schnellen und sicheren Entfernen von Schleifspuren ab Körnung P2000 oder feiner. Velcro.</p> <p>Description: The specially developed foam structure prevents excessive heat and quickly removes light surface damage films such as holograms on dark shades. For the perfect finish. Velcro.</p>
--	--

<p>Antihologramm Polierschwamm</p> <p>8171</p> <p>NEW</p> 	<p>Antihologram Polishing Sponge</p> <p>Art.-Nr. Part.-No. 8171.0160</p> <p>Abmessung Size 160mm</p> <p>VE/Stück Units 2</p> <p>Beschreibung: Offenporiger weicher Schwamm speziell zum Entfernen von Hologrammen. Zur Verwendung mit 8052 Antihologrammpolitur.</p> <p>Description: Soft sponge specially for removing holograms. To use with 8052 Antihologramm polishing compound.</p>
---	--

<p>Polierschwamm inkl. Stützteller weiß</p> <p>8200</p> 	<p>Polishing Pad, backing plate, white</p> <p>Art.-Nr. Part.-No. 8200.1501</p> <p>Ausführung Size 150 x 50mm, M14</p> <p>VE/Stück Units 1</p> <p>Beschreibung: Polierschwamm inkl. Stützteller zur maschinellen Verarbeitung von Schleif- und Polierpasten. Fester Schaum, ideal für alle modernen Lacksysteme.</p> <p>Description: Polishing sponge with integrated backing pad for mechanical use of cutting and polishing compounds. Rigid Foam.</p>
--	--

<p>Polishing Pad, backing plate, blue</p> <p>Art.-Nr. Part.-No. 8220.1501</p> <p>Ausführung Size 150 x 50mm, M14</p> <p>VE/Stück Units 1</p> <p>Beschreibung: Polierschwamm inkl. Stützteller zur maschinellen Verarbeitung von Schleif- und Polierpasten. Medium fester Schaum, universell einsetzbar.</p> <p>Description: Polishing sponge with integrated backing pad for mechanical use of cutting and polishing compounds. An all purpose foam with a medium grade density.</p>	
---	---

<p>Polishing Pad, backing plate, red</p> <p>Art.-Nr. Part.-No. 8230.1501</p> <p>Ausführung Size 150 x 50mm, M14</p> <p>VE/Stück Units 1</p> <p>Beschreibung: Polierschwamm inkl. Stützteller zur maschinellen Verarbeitung von Schleif- und Polierpasten. Weicher Schaum.</p> <p>Description: Polishing sponge with integrated backing pad for mechanical use of cutting and polishing compounds. Soft foam. Perfect for final polishing. Ultra soft.</p>	
--	---

<p>Backing Plate</p> <p>Art.-Nr. Part.-No. 8250.0014, 8250.0075, 8250.0117</p> <p>Ausführung Size 117mm, M14; 75mm, M14; 123mm, M14, soft</p> <p>VE/Stück Units 1, 1, 1</p> <p>Beschreibung: Stützteller für die maschinelle Verarbeitung von Polierschwämmen. Velcro.</p> <p>Description: Backing Pad for holding Velcro backed foams.</p>	
--	--

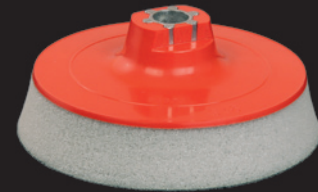
<p>Backing Plate ultra soft</p> <p>Art.-Nr. Part.-No. 8255.0014</p> <p>Ausführung Size 148mm, M14</p> <p>VE/Stück Units 1</p> <p>Beschreibung: Stützteller für die maschinelle Verarbeitung von Polierhauben 8500. Velcro.</p> <p>Description: 25mm soft foam layer for curved or delicate surfaces. Particularly suitable for our polishing bonnets 8500. Velcro.</p>	
---	---

<p>Hand Backing Pad</p> <p>Art.-Nr. Part.-No. 8260.0150</p> <p>Ausführung Size 150mm</p> <p>VE/Stück Units 1</p> <p>Beschreibung: Flexibler Handstützteller zur manuellen Verarbeitung von Polierschwämmen oder Schleifscheiben. Velcro.</p> <p>Description: Perfect for curved surfaces and detailing. Can be used with both foams and abrasive discs. Velcro.</p>	
--	---

<p>Backing Plate soft</p> <p>Art.-Nr. Part.-No. 8265.0130</p> <p>Abmessung Size 130mm</p> <p>VE/Stück Units 1</p> <p>Beschreibung: Flexibler Stützteller durch Zweischäumtechnik, universell für ebene sowie gerundete Flächen einsetzbar. Mit abgefräster Klettkaute für längere Haltbarkeit.</p> <p>Description: Flexible backing pad with "two foam technology", can be used universally on even or rounded surfaces. With special Velcro edge for longer product-life.</p>	
---	---

<p>Polierschwamm inkl. Stützteller blau</p> <p>8220</p>	
---	---

<p>Polierschwamm inkl. Stützteller rot</p> <p>8230</p>	
--	---

<p>Stützteller für Polierschwamm</p> <p>8250</p>	
--	--

<p>Stützteller ultra soft</p> <p>8255</p>	
---	---

<p>Handstützteller</p> <p>8260</p>	
--	---

<p>Stützteller soft</p> <p>8265</p> <p>NEW</p>	
---	---

Handpuck grün 8266 NEW	Handpuck green Beschreibung: Zum gleichmäßigen Auftragen der Handpolitur. Auswaschbar. Description: For an even application of the Hand Polish. Washable.	Art.-Nr. Part.-No. 8266.0110	Abmessung Size 110mm	VE/Stück Units 1
---	--	--	--------------------------------	----------------------------



Schleifblüten 8300	Mini Sanding Discs Beschreibung: Für punktuellen Ausschleifen von Staubeinschlüssen und Fehlstellen im Decklack. Description: For hand sanding of imperfections in the final top coat.	Art.-Nr. Part.-No. 8300.0100 8300.0101 8300.3001	Ausführung Size selbstklebend - self-adhesive Velcro Velcro	Körnung Grit P 2000 P 2000 P 3000	VE/Stück Units 1 x 100 1 x 100 1 x 100
-------------------------------------	---	--	---	---	--



Schleifblütenklotz 8301	Sanding Block for mini discs Beschreibung: Zur manuellen Verarbeitung von 4CR Schleifblüten 8300. Description: For the manual use of 4CR Mini Sanding Discs 8300.	Art.-Nr. Part.-No. 8301.0001 8301.0002	Ausführung Size selbstklebend - self-adhesive Velcro	VE/Stück Units 1 1
--	--	---	---	---------------------------------



Poliertuch 8400	Polishing Cloth Beschreibung: Fusselfreies, weiches Polierrtuch zum Aufpolieren von frischen und verwitterten Lackoberflächen. Description: Lint free, very soft polishing cloth for polishing fresh and old paint surfaces.	Art.-Nr. Part.-No. 8400.0400	Abmessung Size 32 x 36cm	Ausführung Size 400 Abr. - pcs.	VE/Stück Units 1
----------------------------------	---	--	------------------------------------	---	----------------------------



Poliertuch strong 8410	Polishing Cloth strong Beschreibung: Besteht aus polyesterverstärktem Zellstoff, saugt Flüssigkeiten schnell und sauber auf wie Papier und ist extrem reißfest wie Kunststoff. Lösungsmittelbeständig. Description: Heavy duty polishing cloth made of polyester reinforced cellulose. Absorbs as quickly as paper, yet is resistant to tearing and solvents like plastic.	Art.-Nr. Part.-No. 8410.0025	Abmessung Size 35 x 38cm	VE/Stück Units 1 x 25
---	---	--	------------------------------------	---------------------------------



Polierhaube 8500	Polishing Bonnet Beschreibung: Polierfell zur maschinellen Verarbeitung von Schleif- und Polierpasten. Velcro. Description: Wool bonnet with Velcro backing. For compounding and polishing.	Art.-Nr. Part.-No. 8500.0150 8500.0151	Gebinde Size 150mm 150mm	Ausführung Size Wolle - wool Naturlammfell - genuine lambskin	VE/Stück Units 5 5
-----------------------------------	--	---	---------------------------------------	--	---------------------------------



Art.-Nr. Part.-No. 8510.0160	Abmessung Size 160mm	VE/Stück Units 2	Synthetic lambswool Beschreibung: Sorgt für einen hohen Abrieb mit geringer Wärmeentwicklung auf der Lackoberfläche. Zum schnellen und sicheren Entfernen von Schleifspuren ab Körnung P1500. Velcro. Description: Synthetic lambswool for high abrasion and low heat build-up on the surface. Removes P1500 grit scratches. Velcro backing.
--	--------------------------------	----------------------------	---



Art.-Nr. Part.-No. 8600.0175	Ausführung Size 150mm Pad	VE/Stück Units 1	Polishing Machine Beschreibung: 1200-Watt-Polierer mit starkem Durchzug, Drehzahlregelung (1000-3300 rpm) und zwei Griffvarianten. Durch perfekte Kühlung ist der Polierer hoch belastbar. Griffhaube und ausgewogene Gewichtsverteilung sorgen für optimale Handhabung. Description: 1200W Polisher with continuously adjustable electronic speed regulation (1000 to 3300 rpm). Easy and safe to handle.
--	-------------------------------------	----------------------------	---



Poliermaschine Polishing Machine 8600



1200-Watt-Polierer mit starkem Durchzug, Drehzahlregelung (660-3000 rpm) und zwei Griffvarianten. Durch perfekte Kühlung ist der Polierer hoch belastbar. Griffhaube und ausgewogene Gewichtsverteilung sorgen für optimale Handhabung.

1200W Polisher with continuously adjustable electronic speed regulation (660 to 3000 rpm). Easy and safe to handle.

4CR

Finish

Ausrüstung | Equipment



Universal Polish

1.  **1500-2000**
Synthetisches Lammfell blau
Sorgt für einen hohen Abrieb. Mit
Kletrücken. Art.-Nr.: 6.8510.0160

2. optional bei dunklen Farbtönen

+  **1500-4000**
Polierschwamm blau 160 mm
Speziell zum Entfernen von Hologrammen
bei starkem Abrieb. Weich, offenporig,
Kletrücken. Art.-Nr.: 6.8151.0160

Universalpolitur Trillenium
silikonfrei
Trillenium Universal Polish
silicone free

Universalpolitur Trillenium
Als Universalpolitur einzusetzende Schleif- und Hochglanzpolitur.
Für alle Lacke geeignet. Inhalt: 1 Liter, Art.-Nr.: 6.8050.1000



Hand Polish

1. Auftragen  **6.8266.0110**
Handpuck grün 110 mm
Zum gleichmäßigen Auftragen
der Handpolitur. Auswaschbar.
Art.-Nr.: 6.8266.0110

2. Abtragen  **6.6255.0001**
Mikrofasertuch Satin
Ultraweicher Floor, extrem saugfähig,
2-seitig, 40x40cm, ohne Kettelung, bis
90° waschbar. Art.-Nr.: 6.6255.0001

Hochglanz Handpolitur grün
silikonfrei
High Gloss Hand Polish green
silicone free

Hochglanz Handpolitur grün
Schützt vor Umwelteinflüssen und schafft einen Hoch- und Tiefenglanz
mit lang anhaltender Versiegelung. Einfache und schnelle Anwendung
per Hand. Inhalt: 1 Liter, Art.-Nr.: 6.8051.1000



High Gloss Polish

 **6.8171.0160**
Antihologramm
Polierschwamm 160 mm
Speziell zum Entfernen von
Hologrammen.
Nur anzuwenden mit 8052
Antihologrammpolitur.
Art.-Nr.: 6.8171.0160

**Stützteller 130 mm, Art.-Nr.:
6.8265.0130**

Antihologrammpolitur hochglanz
silikonfrei
Antihologram Polish high gloss
silicone free

Antihologrammpolitur hochglanz
Beseitigt Hologramme dauerhaft und effizient. Besonders geeignet für
die Verwendung auf dunklen Farbtönen. Sorgt für einen sichtbaren
Tiefenglanz. Inhalt: 500 ml, Art.-Nr.: 6.8052.0500



for car refinsh

www.4CR.com

Spritzpistole HVLP | **Spray Gun HVLP**

9030 

Beschreibung: HVLP Fließbecherpistole mit einer Übertragungsrate über 65 %. Für fast alle Lackmaterialien geeignet. Ergonomischer Griff. Feine Zerstäubung. Edelstahldüsentteile. Arbeitsdruck ab 2,5 bar.
Description: HVLP spray gun with an efficiency rate up to 65 %. For all paints. Ergonomic grip. Fine atomization. Stainless steel nozzle parts. Working pressure over 2,5 bar = 35 to 45 psi.

Art.-Nr. Part.-No.	Ausführung Size	VE/Stück Units
9030.0012	1,2mm	1
9030.0014	1,4mm	1
9030.0017	1,7mm	1

Düsensatz für 9030 | **Nozzle Set for 9030**

9031 

Beschreibung: Düsensatz für 9030 4CR Fließbecherpistole.
Description: Nozzle Set for 9030 4CR Paint Gun.

Art.-Nr. Part.-No.	Ausführung Size	VE/Stück Units
9031.0012	1,2mm	1
9031.0014	1,4mm	1
9031.0017	1,7mm	1
9031.0020	2,0mm	1
9031.0022	2,2mm	1
9031.0025	2,5mm	1

Reparaturset für 9030 | **Repair Set for 9030**

9032 

Beschreibung: Reparaturset für 9030 4CR Fließbecherpistole. 16 Teile.
Description: Repair Set for 9030 4CR Paint Gun. 16 parts.

Art.-Nr. Part.-No.	VE/Stück Units
9032.0001	1

Dichtungssatz für 9030 | **Gasket Set for 9030**

9033 

Beschreibung: Dichtungssatz für 9030 4CR Fließbecherpistole. 5 Teile.
Description: Gasket Set for 9030 4CR Paint Gun. 5 parts.

Art.-Nr. Part.-No.	VE/Stück Units
9033.0001	1

Fließbecher | **Gravity Cup white**

9034 

Beschreibung: 600ml Kunststoff-Fließbecher für Spritzpistolen.
Description: 20 oz plastic gravity cup for paint guns.

Art.-Nr. Part.-No.	Farbe Colour	Ausführung Size	VE/Stück Units
9034.0600	weiß - white	600 ml	1

Schwenk-Drehnippel | **Swivel**

9040 

Beschreibung: Schwenk-Drehnippel mit Innengewinde 1/4 inch.
Description: Swivel - joint with plug 1/4inch, inside thread.

Art.-Nr. Part.-No.	Ausführung Size	VE/Stück Units
9040.0001	1/4 inch	1

Air-Micrometer

9044 

Beschreibung: Luft-Mikrometer aus Messing, zum Teil vernickelt. Gewinde 1/4". Zur stufenlose Verstellung der Luftdurchflussmenge.
Description: For a free regulation of the amount of air flow. Thread 1/4".

Art.-Nr. Part.-No.	Ausführung Size	VE/Stück Units
9044.0001	1/4"	1

Air Regulator

9045 

Beschreibung: Luftregulator mit Minimanometer. Messbereich 0-6 bar (0-87 psi).
Description: Air regulator with mini pressure gauge. Range 0-6 bar (0-87psi).

Art.-Nr. Part.-No.	Ausführung Size	VE/Stück Units
9045.0001	1/4 inch	1

Spray Gun Cleaning Set

9050 

Beschreibung: Set bestehend aus Öl, verschiedenen Bürsten und Nadeln für die Reinigung von Spritzpistolen.
Description: Everything you need to clean and maintain any type of spray gun.

Art.-Nr. Part.-No.	VE/Stück Units
9050.0001	1

Rotating Spray Stand

9100 

Beschreibung: Fahrbarer Drehlackierstand (inkl. Haltearme und Klammern) zur Aufnahme von Türen, Motorhauben, etc.
Description: Mobile and rotating paint stand (incl. arms and clamps) for working on doors, hoods, etc.

Art.-Nr. Part.-No.	Ausführung Size	VE/Stück Units
9100.0001	Standard - standard	1
9100.0002	Ersatzklammern - replacement clips	1
9100.0004	Haltearm - hoodholder	1

Holder for small parts

9105 

Beschreibung: Halterung für 9141 und 9142. Zum Lackieren kleinerer Teile. Lässt sich problemlos an den Drehlackierstand 9100 montieren. (Abbildung: Kleinteile 9141 und 9142 nicht mit im Lieferumfang enthalten.)
Description: For clamping and holding small parts. Can be easily mounted onto 9100 Spray Stand. (delivery without pictured small parts)

Art.-Nr. Part.-No.	VE/Stück Units
9105.0001	1

Door Stand

9110 

Beschreibung: Fahrbarer Ständer für Autotüren und andere Teile. Verzinkte Stahlkonstruktion.
Description: Holds onto door securely while giving maximum spray access. 40 x 24 x 50 inch.

Art.-Nr. Part.-No.	Abmessung Size	VE/Stück Units
9110.0001	100 x 60 x 125cm	1

Luft-Mikrometer

9044 

NEW

Druckluftregulator

9045 

Reinigungs- und Bürstenset

9050 

Drehlackierstand

9100 

Kleinteilhalter

9105 

Türständer

9110 

Lackierständer

9120



Spray Stand

Art.-Nr. Part.-No. 9120.0001 9120.0002

Abmessung Size 90 x 90 x 160cm 105 x 60 x 100cm

VE/Stück Units 1 1

Beschreibung: Fahrbarer, stabiler Ständer für eine perfekte Lackier- und Schleifposition.
Description: Multi-purpose parts stand for secure positioning and good access while spraying. 36 x 36 x 64 inch.

Art.-Nr. Part.-No. 9143.0003

Ausführung Size Set à 3 Stck. - pcs.

VE/Stück Units 1

Parts Prop

Beschreibung: Diese praktischen und verstellbaren Halter fixieren Heckklappen, Motorhauben und Türen.
Description: Adjustable, perfect for holding open hoods, lids, doors, etc.

Abstandshalter

9143



Felgenspitz

9125



Wheel Holder

Art.-Nr. Part.-No. 9125.0001

VE/Stück Units 1

Beschreibung: Zum Lackieren von Felgen. Lässt sich problemlos an alle gängigen Lackierständer montieren.
Description: Designed for perfect positioning of wheel rims while spraying.

Art.-Nr. Part.-No. 9150.0001 9150.0002

Abmessung Size 116 x 70cm 61 x 128cm

Ausführung Size Standard - standard premium

VE/Stück Units 1 1

X-Stand

Beschreibung: X-Ständer zur Bearbeitung von Motorhauben u.ä. Höhenverstellbar.
Description: X-stand for working on hoods, etc.

X-Ständer

9150



Multifunktionsständer

9130



Multi Spray Stand

Art.-Nr. Part.-No. 9130.0001

VE/Stück Units 1

Beschreibung: Multifunktionaler Lackiertisch für große und kleine Karosserieteile.
Description: Multi-purpose stand.

Art.-Nr. Part.-No. 9160.0001

Abmessung Size max. 130 x 95cm

VE/Stück Units 1

Universal Stand

Beschreibung: Sehr stabiler und universell einsetzbarer Ständer. In Länge und Breite verstellbar.
Description: Stable, universal stand, adjustable in both length and width. 52 x 38 inch.

Universalständer

9160



Kleinteilisch

9140



Table for small parts

Art.-Nr. Part.-No. 9140.0001

VE/Stück Units 1

Beschreibung: Zum Lackieren kleinerer Teile innerhalb oder außerhalb der Lackierkabine. Zu verwenden u.a. mit 9141 und 9142. Lieferung ohne Lackierklammern.
Description: For use with 9141 and 9142, either inside or outside the paint booth. No clamps with the delivery.

Art.-Nr. Part.-No. 9200.0001

Ausführung Size Standard - standard

VE/Stück Units 1

Masking Trolley

Beschreibung: Abrollwagen für Abdeckfolien.
Description: Mobile dispenser for masking plastic.

Folienabroller

9200



Lackierklammer

9141



Painting Clamp

Art.-Nr. Part.-No. 9141.0010 9141.0020 9141.0030

Abmessung Size 10cm 20cm 30cm

VE/Stück Units 1 1 1

Beschreibung: Mit diesen Klammern in unterschiedlichen Größen können Kleinteile optimal zum Lackieren fixiert werden.
Description: Secures parts for painting and drying.

Art.-Nr. Part.-No. 9250.0001 9250.0002 9250.0003 9250.0004

Ausführung Size Wand (22 - 90cm) - wall (22 - 90cm) Diagonal (22 - 90cm) - diagonal (22 - 90cm) Premium (22 - 90cm) - premium (22 - 90cm) XXL (22 - 120cm)

VE/Stück Units 1 1 1 1

Paper Masking Trolley

Beschreibung: Abrollgeräte für Abdeckpapier. Sehr einfaches Austauschen der Papierrollen.
Description: Mobile dispensing unit for masking paper.

Papierabroller

9250



Spiegelhalter

9142

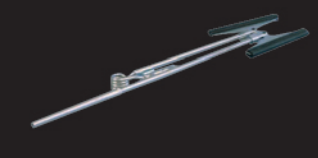

Mirror Holder

Art.-Nr. Part.-No. 9142.0001

VE/Stück Units 1

Beschreibung: Speziell entwickelt um Spiegel für die Lackierung zu halten.
Description: Holds securely while providing maximum access.

Art.-Nr. Part.-No. 9251.0001 9251.0002 9251.0003

Ausführung Size Wand - wall Standard - standard premium

VE/Stück Units 1 1 1

Towel Cart

Beschreibung: Robuste und platzsparende Abroller für Putzpapierrollen.
Description: Mobile dispensing unit for cleaning towels.

Putzrollenhalter

9251



Stahlschrank 9300	Steel cabinet Beschreibung: Hochwertiger Stahlschrank zur optimalen Aufbewahrung von 4CR Produkten in der Werkstatt. Inkl. 4 Regalböden, ohne dargestellte Dekoration. Description: High-quality steel cabinet for storage of 4CR products in the bodyshop (4 shelf boards included). Note: Products shown in cabinet are not included with purchase of cabinet.	Art.-Nr. Part.-No. 9300.0001 9300.0002	Abmessung Size 95 x 50 x 195cm Fachboden - lower shelf	VE/Stück Units 1 1
------------------------------------	---	---	---	---------------------------------

Teilewagen 9325	Parts Cart Beschreibung: Fahrbarer Teilewagen inkl. zwei Regalen zur Aufbewahrung von z.B. Motorhauben, Türen, Stoßstangen, etc. Description: Mobile cart for autobody parts, products, tools, etc. Stack large parts below or on top. 48 x 32 x 72 inch.	Art.-Nr. Part.-No. 9325.0001	Abmessung Size 109 x 76 x 166cm	VE/Stück Units 1
----------------------------------	--	--	---	----------------------------

Teileständer 9330	Parts Stand Beschreibung: Fahrbarer Teileständer zur optimalen Aufbewahrung von z.B. Stoßstangen, Blechen, etc. Description: Mobile cart for perfect storage of bumpers and sheet metal. 48 x 32 x 80 inch.	Art.-Nr. Part.-No. 9330.0001	Abmessung Size 120 x 80 x 200cm	VE/Stück Units 1
------------------------------------	--	--	---	----------------------------

Werkstatteimer 9350	3-Gallon Bucket Beschreibung: Universell einsetzbarer Werkstatteimer. Fassungsvermögen: 10,7 l. Description: Ideal for soaking and rinsing sandpaper, sponges, etc.	Art.-Nr. Part.-No. 9350.0107	Ausführung Size 10,7 l	VE/Stück Units 1
--------------------------------------	--	--	----------------------------------	----------------------------

Arbeitstisch Edelstahl 9361	Stainless Steel Work Bench Beschreibung: Arbeitstisch mit Absaugvorrichtung. Komplett aus Edelstahl. Description: High quality steel, prefitted for vacuum attachments.	Art.-Nr. Part.-No. 9361.0001 9361.0002	Abmessung Size 120 x 60 x 140cm 180 x 60 x 140cm	VE/Stück Units 1 1
--	--	---	---	---------------------------------

Anmisch- und Arbeitstisch 9365	Mixing Table Beschreibung: Anmisch- und Arbeitstisch für Lackierer. Mit Lackierpistolen- und Papierrollenhalter. Für mehr Ordnung und Übersicht am Arbeitsplatz. Description: Mixing and work table for painter. With paint gun holder and towel dispenser.	Art.-Nr. Part.-No. 9365.0001	Abmessung Size 118 x 62 x 142cm	Ausführung Size standard	VE/Stück Units 1
---	--	--	---	------------------------------------	----------------------------

Art.-Nr. Part.-No. 9380.0002	Ausführung Size magnetisch - magnetic	VE/Stück Units 1
--	---	----------------------------

Art.-Nr. Part.-No. 9385.0001	VE/Stück Units 1
--	----------------------------

Art.-Nr. Part.-No. 9400.0003 9400.0010	Ausführung Size 3 kg 32 EX 10 kg 42/39 EX	VE/Stück Units 1 1
---	--	---------------------------------

Art.-Nr. Part.-No. 9410.0003	Ausführung Size 3 kg	VE/Stück Units 1
--	--------------------------------	----------------------------

Art.-Nr. Part.-No. 9450.0001 9450.0002	Ausführung Size pneumatisch - pneumatic manuell - manual	VE/Stück Units 1 1
---	---	---------------------------------

Art.-Nr. Part.-No. 9505.0001	VE/Stück Units 1
--	----------------------------

Spraygun Holder Beschreibung: Haltevorrichtung für zwei Lackierpistolen. Description: Magnetic holder for spray guns. Designed for 2 guns.	Art.-Nr. Part.-No. 9380
---	-----------------------------------

DA Sander Holder Beschreibung: Haltevorrichtung für Schleifmaschinen. Description: Keeps your sander off the floor.	Art.-Nr. Part.-No. 9385
--	-----------------------------------

Putty Dispenser pneumatic Beschreibung: Pneumatischer Dispenser zur exakten Dosierung von Spachtelmassen und Härter. Einstellbare Härtermenge. Description: Pneumatic dispenser for precise measuring of polyester putty and hardener.	Art.-Nr. Part.-No. 9400
---	-----------------------------------

Putty Dispenser manual Beschreibung: Manueller Dispenser zur exakten Dosierung von Spachtelmasse und Härter mit Abschneidefunktion. Geeignet für zentrische und exzentrische 3-kg-Spachtelkartuschen. Description: Manual dispenser for precise measuring of polyester putty and hardener. For 3 kg cartridges.	Art.-Nr. Part.-No. 9410
--	-----------------------------------

Prefill Aerosol Filling Machine Beschreibung: Gerät zur Befüllung der 4CR Prefill-Spraydosen 7440. Description: Machine to fill the 4CR Prefill aerosols (7440).	Art.-Nr. Part.-No. 9450
---	-----------------------------------

Air Jet Beschreibung: Zur Entfernung von Staub und zur schnelleren Trocknung von wasserbasierenden Beschichtungen. Description: This hand held blower delivers a flat jet of compressed air. Used for spot repair and dry paint in door shuts etc.	Art.-Nr. Part.-No. 9505
---	-----------------------------------

Ausblasdüse	Air Nozzle	Art.-Nr. Part.-No.	Ausführung Size	VE/Stück Units
9510	Beschreibung: Ausblasdüse mit Schnellkupplung und Gummiteilstück zur einfachen Regulierung des Luftstroms. Description: Air nozzle with quick connect and easy to turn rubber nozzle for adjusting airflow.	9510.0001	EU	1



Ausblasstift	Air Nozzle pen	Art.-Nr. Part.-No.	Ausführung Size	VE/Stück Units
9515	Beschreibung: Ausblasstift in Kugelschreiberform. Duraluminium-Gehäuse mit Clip zum Befestigen am Overall. Description: Pen style air nozzle with pocket clip.	9515.0001 9515.0002	EU CH, NL	5 5

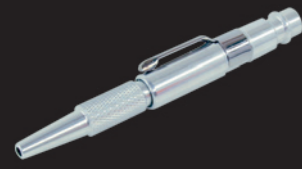

Trockenblaspistole	Venturi Air Dry Gun	Art.-Nr. Part.-No.	Ausführung Size	VE/Stück Units
9520	Beschreibung: Venturi Luftpistole zur Reduzierung der Trocknungszeiten, speziell bei wasserbasierenden Lacken. Description: Venturi effect gun for directing air to accelerate flash times and overall evaporation. Works for both waterborne and solvent based coatings.	9520.0001 9520.0002	Ersatzfilter - replacement filter	1 1



Trockenblasstativ	Stationary Venturi Unit	Art.-Nr. Part.-No.	VE/Stück Units
9530	Beschreibung: Stativ mit zwei abnehmbaren Venturi Luftpistolen zur Reduzierung der Trocknungszeiten, speziell bei wasserbasierenden Lacken. Höhenverstellbar von 30-210 cm. Description: Stand and two removable Venturi effect guns, for flashing and drying larger surfaces. Works on both waterborne and solvent based coatings. Height adjustment from 12 - 82.5 inch.	9530.0001	1



Infrarottrockner	Infrared Dryer	Art.-Nr. Part.-No.	Ausführung Size	VE/Stück Units
9750	Beschreibung: Mobile Infrarot Lacktrockner. Die kurzwellige Energie dringt in die Lackschicht ein und trocknet auch von Innen heraus. Langelebige Röhren (bis zu 6.000 Arbeitsstunden). Description: Mobile short-wave infra-red dryer. Pre heat function to achieve gradual temperature increase. Individual adjustable emitter cassettes with a long life emitter (up to 6000 hours). Powerful penetration directly into the inner paint layer.	9750.0001 9750.0003 9750.0006 9750.0012 9750.0013 9750.0014 9750.0015 9750.0016	1 Röhre - emitter 3 Röhren - emitter 6 Röhren - emitter Ersatzröhre - replacement emitter (1100W 230V) Pneum. Stützfeder - spring Abstandssensor - distance sensor Platine - circuit board f. 9750.0001 Platine - circuit board f. 9750.0003	1 1 1 1 1 1 1 1



9030 Spritzpistole HVLP
Spray Gun HVLP



HVLP Fließbecherpistole mit einer Übertragungsrage über 65 %. Für fast alle Lackmaterialien geeignet. Ergonomischer Griff. Feine Zerstäubung. Edelstahldüsentteile. Arbeitsdruck ab 2,5 bar.

HVLP spray gun with an efficiency rate up to 65 %. For all paints. Ergonomic grip. Fine atomization. Stainless steel nozzle parts. Working pressure over 2,5 bar = 35 to 45 psi.

Härter-Verdünnung | Hardener-Thinner



2K MS-Füllerhärter 5:1

0041



2K MS-Primer Hardener 5:1

Art.-Nr. Part.-No. Ausführung Size VE/Stück Units

0041.0201 0041.1001 0,2l 1l 12 6

Beschreibung: Härter für 4150 2K MS-Füller 5:1 und 7150 2K ECO-Klarlack.

Description: Hardener for 4150 MS-2K Primer and 7150 EXO-Clearcoat.

1K Acryl-Umwandler

0100



1K Acrylic-Converter

Art.-Nr. Part.-No. Gebinde Size VE/Stück Units

0100.1000 1ltr 6

Beschreibung: Zur Umwandlung von 2K-AC-Lacken zu 1K-Acryllacken. Härterzugabe entfällt nach 1K Acryl-Umwandler Zugabe.

Description: Enables 2K-AC paints to be converted into an 1K-Acrylic-Paint. No hardener necessary after the addition of 4CR 1K Acrylic-Converter.

Universal Härter

0407



Universal Hardener

Art.-Nr. Part.-No. Ausführung Size VE/Stück Units

0407.0251 0407.0253 0407.0501 0407.0503 0407.1001 0407.1002 0407.1003 0407.2501 0407.2502 0407.2503 0407.2507

0,25l kurz - fast
0,25l standard
0,5l kurz - fast
0,5l standard
1,0l kurz - fast
1,0l extra kurz - extra fast
1,0l standard
2,5l kurz - fast
2,5l extra kurz - extra fast
2,5l standard
2,5l extra lang - extra slow

12
12
6
6
6
6
6
4
4
4
4

Beschreibung: Vielseitig verwendbarer, UV-beständiger Härter auf Isocyanat-Basis für 2K-Lacke, 2K-Grundierungen, 2K-Füller und 2K-Klarlacke.

Description: Multi-purpose, UV-reistant hardener based on isocyanate for 4CR 2K-paints, 2K-primers, 2K-fillers, 2K-clearcoats, etc.

2K HS-Härter Low VOC

0408



2K HS-Hardener Low VOC

Art.-Nr. Part.-No. Ausführung Size VE/Stück Units

0408.0251 0408.0253 0408.0501 0408.0503 0408.1001 0408.1003 0408.2501 0408.2503 0408.2506

0,25l kurz - fast
0,25l standard
0,5l kurz - fast
0,5l standard
1l kurz - fast
0,5l standard
2,5l kurz - fast
2,5l standard
2,5l extra lang - extra slow

12
12
6
6
6
6
4
4
4

Beschreibung: 2K Acryl-Härter für verschiedene 2K-Lacke, 2K-Grundierungen, 2K-Füller und 2K-Klarlacke.

Description: Isocyanate hardener for various 2K filler, paints and Clearcoats.

2K Härter für Waschprimer

0410



2K Hardener for wash primer

Art.-Nr. Part.-No. Gebinde Size VE/Stück Units

0410.0500 0,5ltr 6

Beschreibung: 2K Härter für 4CR 4100 2K Waschprimer 2:1.

Description: 0410 is the 2K Hardener for 4CR 4100 2K Wash primer 2:1.

2K EP-Härter

0451



2K EP-Hardener

Art.-Nr. Part.-No. Gebinde Size VE/Stück Units

0451.0501 0451.0503 0,5l kurz - fast
0,5l standard

6
6

Beschreibung: Härter für 4CR 4510 2K Epoxid-Grundierung. 0451.0501 2K EP-Härter kurz mit stark beschleunigter An- und Durchtrocknung. Zum Einsatz bei Temperaturen von 5 - 15°C oder zur Verkürzung der Trockenzeit um ca. 50% im Vergleich zu EP-Härter standard.

Description: Hardener for 4CR 4510 2K Epoxy-Primer. 0451.0501 2K EP-Hardener fast with accelerated drying. To be used at temperatures between 5 to 15°C or to reduce the drying time by 50% comparing to EP-Hardener standard.

Art.-Nr. Part.-No. Gebinde Size VE/Stück Units

0500.1000 0500.5000 1ltr 5ltr 6 6

Active Thinner ++

Beschreibung: 2K-Verdünnung extra kurz zur Beschleunigung der Durchtrocknung speziell bei HS-Klarlacken. Ersetzt die Zugabe der Verdünnung 0505.

Description: 2K-Thinner extra fast speeds up the drying time in use with UHS and HS Clearcoats. Replaces the addition of 0505 Thinner.

Art.-Nr. Part.-No. Ausführung Size VE/Stück Units

0505.1000 0505.1001 0505.5000 0505.5001 1l standard
1l lang - slow
5l standard
5l lang - slow

6
6
4
4

Universal Urethane Reducer

Beschreibung: Acrylverdünnung für alle 2-Komponenten Acryl-Produkte aller handelsüblicher Systeme. Die Verdünnung kann sowohl zum Einstellen der Spritzviskosität oder allgemein zur Verbesserung der Verarbeitbarkeit als auch zum Reinigen der Werkzeuge benutzt werden.

Description: For reducing high-end 2K acrylic urethane coatings. Available in two speeds.

Art.-Nr. Part.-No. Ausführung Size VE/Stück Units

0510.5000 0510.5001 5l standard
5l lang - slow

4
4

Basecoat Thinner

Beschreibung: Gemisch organischer Lösemittel zum Verdünnen von BC-Lacken.

Description: For use with high-end European basecoats. Two speeds.

Art.-Nr. Part.-No. Ausführung Size VE/Stück Units

0515.5000 5l 4

2K Fade-out-thinner

Beschreibung: Lösemittelmischung zur Auflösung von Spritznebelrändern bei Punktausbesserungen und Beilackierungen.

Description: 2K Fade-out-thinner to initiate the dissolution of old paint and/or pretreatment of spot repair refinish.

Art.-Nr. Part.-No. Ausführung Size VE/Stück Units

0520.1000 1l 6

PE-Thinner

Beschreibung: Zur Verdünnung von Polyester-Systemen.

Description: Reducer for thinning polyester putties.

Art.-Nr. Part.-No. Ausführung Size VE/Stück Units

0610.1000 0610.5000 1l 5l 6 4

Silicone Remover

Beschreibung: Reinigungs- und Entfettungsmittel für alle metallischen und polymeren Werkstoffe.

Description: For degreasing vehide surfaces.

Aktivverdünnung ++

0500



2K Acrylverdünnung

0505



2K Acrylverdünnung

0505



Basecoat Verdünnung

0510



2K Löser

0515



PE-Verdünnung

0520



Silikonentferner

0610



WB Silikonentferner 0620 	WB Silicone Remover Beschreibung: Geruchsmildes und VOC-konformes Entfettungsmittel auf Wasserbasis zur Vorreinigung von Metall- und Kunststoffuntergründen, gefüllten Flächen und angeschliffenen Altlacken. Description: Low odour, water-borne degreaser for the refinsh market. Environmentally friendly alternative to traditional products. To be used for pre-cleaning the metal and plastics substrates, filled surfaces and well sanded old coats.	Art.-Nr. Part.-No. 0620.1000 0620.5000	Gebinde Size 1ltr 5ltr	VE/Stück Units 6 4
VE-Wasser 0660 	Demineralised Water Beschreibung: Zur Verdünnung von 4370 WB Primer. Description: For reducing 4370 WB Primer.	Art.-Nr. Part.-No. 0660.1000	Gebinde Size 1l	VE/Stück Units 6
2K Elastifizierungszusatz 0700 	2K Plasticiser Additive Beschreibung: Zusatzmittel zur Erhöhung der Elastizität von 2K-Auto-, 2K-Fahrzeug- und 2K-Klarlacken. Notwendig bei der Lackierung von verformbaren Kunststoffen. Description: Additive used to increase the elasticity of 2K - OC, AC, PUR paints and 2K acrylic clearcoats. Required for the painting of flexible plastics.	Art.-Nr. Part.-No. 0700.0500	Gebinde Size 0,5ltr	VE/Stück Units 6
Mattierungszusatz 0720 	Matting Additive Beschreibung: Universal-Mattierungsmittel zur Reduzierung des Glanzes von 1K- und 2K-Decklacken (HS, UHS, PUR-, Kunstharz-, Nitrokombi-, PVC-Lacke). Flüssig, leicht einrührbar. Description: Universal Matting Additive used to reduce the gloss degree of 1K- and 2K-Top coats (PUR, OC, PUR HS, UHS, synthetic enamel, Nitro-Combi, PVC paints). Fluid, easy to mix.	Art.-Nr. Part.-No. 0720.1000	Gebinde Size 1ltr	VE/Stück Units 6

7255 UHS-Klarlack 2:1 VOC 420 UHS Clearcoat 2:1 VOC 420



VOC- konformer Ultra-High-Solid-Klarlack. Hoher Festkörpergehalt. Sehr gutes Verlauf-und Glanzverhalten. Nur zu verarbeiten mit Härter 0409. Keine Verdünnung erforderlich.

Ultra High-Solid Clearcoat with optimum flow. Easy to use. High gloss. Fulfills the VOC-prescriptions within the EU. Activate only with 0409 hardener. No thinners needed.

Meet the brand Point of presentation



www.4CR.com

KWK Holding KG
Dieselstraße 10-12
D-25813 Husum
Germany

Tel.: +49 48 41-990 28
Fax: +49 48 41-990 29
www.4CR.com

Your local 4CR dealer:

